

Inleiding

Inhoudsopgave

Index



Aan de slag gaan



Basishandelingen  
van de camera



Opnamen maken



Afspelen



Draadloze functies



Overige instellingen



## Opmerkingen vooraf en wettelijke informatie



- Maak enkele testopnamen en bekijk deze om te controleren of de beelden goed zijn opgenomen. Canon Inc., dochterondernemingen van Canon en andere aangesloten bedrijven en distributeurs zijn niet aansprakelijk voor welke gevolgschade dan ook die voortvloeit uit enige fout in de werking van een camera of accessoire, inclusief kaarten, die ertoe leidt dat een opname niet kan worden gemaakt of niet kan worden gelezen door apparaten.
- Wanneer de gebruiker onrechtmatig mensen of materiaal waarop auteursrecht rust fotografeert of opneemt (video en/of geluid), kan dit de privacy van deze mensen schenden en/of een inbreuk zijn op de juridische rechten van anderen, waaronder auteursrechten en andere intellectuele eigendomsrechten. Er kunnen zelfs beperkingen gelden wanneer dergelijke foto's of opnamen uitsluitend voor persoonlijk gebruik zijn bedoeld.
- Meer informatie over de garantie voor uw camera of de Klantenservice vindt u in de garantie-informatie in het pakket met de gebruikershandleiding dat bij uw camera wordt geleverd.
- Hoewel het scherm onder productieomstandigheden voor uitzonderlijk hoge precisie is vervaardigd en meer dan 99,99% van de pixels voldoet aan de ontwerpspecificaties, kunnen pixels in zeldzame gevallen gebreken vertonen of als rode en zwarte punten zichtbaar zijn. Dit is geen teken van beschadiging van de camera en heeft geen invloed op de opgenomen beelden.
- De camera kan warm worden als deze gedurende langere tijd wordt gebruikt. Dit is geen teken van beschadiging.



# Inleiding

## Bovenste pagina



- (1) Naar deze pagina springen  
Dit deel beschrijft hoe u door de handleiding bladert en welke conventies in de handleiding worden gebruikt.
- (2) Naar de inhoudsopgave en indexpagina's springen
- (3) Naar de eerste pagina van een deel springen door op een van de zes delen te klikken



# Inleiding Portaalpagina's



Portaalpagina's vormen een poort naar elk deel.

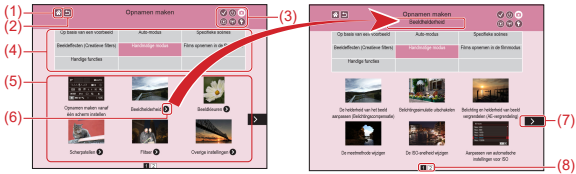

- (1) Naar de eerste pagina springen
- (2) Terugkeren naar de vorige pagina
- (3) Pictogrammen van delen

Klik op een pictogram om naar de portaalpagina van het deel te springen.

- (4) Thema's van delen

Onderwerpen in het geselecteerde thema worden getoond in (5). Houd er rekening mee dat sommige portaalpagina's geen thema's hebben.





## Inleiding Portaalpagina's



- (5) Onderwerpen in het geselecteerde thema. Klik op een onderwerptitel om naar de onderwerppagina te springen.
- (6) Geeft meerdere onderwerpen aan
- (7) Geeft aan dat de informatie verdergaat op de volgende pagina
- (8) Geeft de huidige pagina van meerdere portaalpagina's aan







## Inleiding

### Conventies in deze handleiding



- Instructies in deze handleiding kunnen pictogrammen bevatten die verwijzen naar cameraknoppen en keuzewielen.
- De volgende cameraknoppen worden met pictogrammen aangeduid.



- Opnamemodi en pictogrammen en tekst op het scherm worden tussen haakjes weergegeven.
- De instructies in deze handleiding gelden voor een camera die op de standaardinstellingen is ingesteld.
- Voor het gemak wordt er naar alle lenzen en vattingsadapters verwezen als “lenzen” en “vattingsadapters” ongeacht of ze worden meegeleverd in de lenzenset of los verkrijgbaar zijn.
- Op de afbeeldingen in deze handleiding is een EF-M15-45mm f/3.5-6.3 IS STM-lens op de camera bevestigd als voorbeeld.
- Voor het gemak verwijst “de geheugenkaart” naar alle ondersteunde geheugenkaarten.
- In deze handleiding wordt verondersteld dat de camera is ingesteld op de P-modus indien de stap “stel de opnamemodus in” wordt weggelaten.



Opmerkingen vooraf en wettelijke informatie

Inleiding

Inhoudsopgave

Veiligheidsinstructies

## Aan de slag gaan

De riem bevestigen

De accu opladen

Een geheugenkaart voorbereiden

De accu plaatsen/verwijderen

Een geheugenkaart plaatsen/verwijderen

De datum en tijd instellen

De weergavetaal instellen

Een lens bevestigen

Een lens verwijderen

EF- en EF-S-lenzen bevestigen

EF- en EF-S-lenzen verwijderen

Een statief gebruiken met EF- of EF-S-lenzen

Beeldstabilisatie bij EF- of EF-S-lenzen gebruiken

De camera vasthouden





## Basishandelingen van de camera

- De camera testen
- Namen van onderdelen
- Aan/uit
- Ontspanknop
- Opnamemodi
- De hoek van het scherm aanpassen
- Kaders op het opnamescherm
- Opties voor opnameweergave
- Opties voor afspelerweergave
- Het scherm Snel instellen gebruiken
- Het menuscherm gebruiken
- Tekens invoeren
- Indicatorweergave
- Aanraakbediening

## Opnamen maken

- Op basis van een voorbeeld
- Auto-modus
- Specifieke scènes



Beeldeffecten (Creatieve filters)

Handmatige modus

Films opnemen in de filmmodus

Handige functies

## Afspelen

Bekijken

Zoeken

Beheren

Beelden wissen

Foto's bewerken

RAW-beelden verwerken met de camera

Films bewerken

## Draadloze functies

Beschikbare draadloze functies

Beelden verzenden naar een smartphone die NFC ondersteunt

Beelden verzenden naar een smartphone die NFC ondersteunt (afspeelmodus)

Beelden verzenden naar een smartphone met Bluetooth

Webservices registreren

Beelden uploaden naar webservices



## Overige instellingen

- Voorkomen dat het AF-hulplicht afgaat
- Het lampje voor rode-ogenreductie uitschakelen
- De weergaveduur van het beeld na opnamen wijzigen
- Beelden opslaan op datum
- Bestandsnummering
- Geheugenkaarten formatteren
- Een low-levelformattering uitvoeren
- Het videosysteem wijzigen
- Eco-modus gebruiken
- De spaarstand aanpassen
- Schermhelderheid
- Het opname-informatiescherm aanpassen
- Het weergave-informatiescherm aanpassen
- Wereldklok
- Datum en tijd
- Weergavetaal
- Camerageluiden dempen
- Camerageluiden activeren



- Hints en tips verbergen
- Opnamemodi als pictogram weergeven
- Het touchscreen aanpassen
- Het touchscreen automatisch vergrendelen
- Automatische sensorreiniging uitschakelen
- Sensorreiniging activeren
- De sensor handmatig reinigen
- Certificatielogo's controleren
- Auteursrechtinformatie instellen die in beelden moet worden vastgelegd
- Alle copyrightinformatie verwijderen
- Standaardinstellingen van de camera herstellen
- Standaardwaarden herstellen voor afzonderlijke camerafuncties

## Index

- Voorzorgsmaatregelen voor draadloze functies (Wi-Fi, Bluetooth en overige)
- Voorzorgsmaatregelen voor storing van radiogolven
- Handelsmerken en licenties
- Vrijwaring



# Veiligheidsinstructies



Zorg dat u deze instructies leest om het product veilig te kunnen gebruiken.  
Volg deze instructies om letsel of schade aan de gebruiker van het product of anderen te voorkomen.



## WAARSCHUWING

Hiermee wordt gewezen op het risico van ernstig letsel of levensgevaar.

- Houd het product buiten bereik van jonge kinderen.

Een nekriem rond de nek van een persoon wikkelen kan leiden tot verstikking.

- Gebruik alleen voedingsbronnen waarvan in deze gebruiksaanwijzing wordt vermeld dat ze kunnen worden gebruikt voor dit product.
- Demonteer of wijzig het product niet.
- Stel het product niet bloot aan harde schokken of trillingen.
- Raak geen blootliggende interne onderdelen aan.
- Stop onmiddellijk met het gebruik van het product in geval van vreemde verschijnselen zoals de aanwezigheid van rook of een vreemde geur.
- Gebruik geen organische oplosmiddelen zoals alcohol, wasbenzine of verfverdunder om het product schoon te maken.
- Laat het product niet nat worden.
- Stop geen vreemde voorwerpen of vloeistoffen in het product.





- Gebruik het product niet op plaatsen waar brandbare gassen aanwezig kunnen zijn.

Dit kan een elektrische schok, explosie of brand veroorzaken.

- Heeft uw product een zoeker, kijk dan niet door de zoeker of de lens naar sterke lichtbronnen zoals de zon op een heldere dag of lasers en andere sterke kunstmatige lichtbronnen.

Dit kan uw gezichtsvermogen beschadigen.

- Neem de volgende instructies in acht bij gebruik van in de winkel verkrijgbare batterijen of bijgeleverde accu's.
  - Gebruik alleen de batterijen/accu's die voor het product bedoeld zijn.
  - Verwarm de batterijen/accu's niet en stel ze niet bloot aan vuur.
  - Laad de batterijen/accu's niet op met niet-goedgekeurde acculaders.
  - Stel de polen niet bloot aan vuil en laat ze niet in contact komen met metalen spelden of andere metalen objecten.
  - Gebruik geen lekkende batterijen/accu's.
  - Breng tape of ander isolatiemateriaal aan over de polen van de batterijen/accu's wanneer u deze weggooit.

Dit kan een elektrische schok, explosie of brand veroorzaken.

Indien een batterij/accu lekt en het materiaal in contact komt met uw huid of kleding, moet u het getroffen gebied grondig afspoelen met stromend water. In geval van contact met de ogen moet u de ogen grondig spoelen met ruime hoeveelheden schoon, stromend water en onmiddellijk medische hulp inroepen.





- Neem de volgende instructies in acht bij gebruik van een acculader of compacte voedingsadapter.
  - Verwijder regelmatig met een droge doek stof dat zich op de stekker en het stopcontact ophoopt.
  - Steek of trek de stekker van het product niet in of uit het stopcontact met natte handen.
  - Gebruik het product niet als de stekker niet volledig in het stopcontact is gestoken.
  - Stel de stekker en de polen niet bloot aan vuil en laat ze niet in contact komen met metalen spelden of andere metalen voorwerpen.
- Raak de acculader of compacte voedingsadapter niet aan tijdens onweer indien deze in het stopcontact is gestoken.
- Plaats geen zware voorwerpen op het netsnoer. Demonteer, breek of wijzig het netsnoer niet.
- Wikkel het product niet in doek of andere materialen tijdens of kort na gebruik, wanneer het product nog steeds een warme temperatuur heeft.
- Houd het product niet langdurig aangesloten op een voedingsbron.  
Dit kan een elektrische schok, explosie of brand veroorzaken.
- Laat het product tijdens gebruik niet langdurig in contact komen met hetzelfde gebied van de huid.

Dit kan leiden tot eerstegraads verbrandingen zoals een rode huid of blaren, zelfs als het product niet heet aanvoelt. Het gebruik van een statief of vergelijkbare apparatuur wordt aanbevolen wanneer het product wordt gebruikt op hete locaties of door mensen met een slechte bloedsomloop of een minder gevoelige huid.





- Volg aanwijzingen op om het product uit te schakelen op plaatsen waar het gebruik ervan verboden is.

Als u dit niet doet, kan de werking van andere apparatuur verstoord raken door het effect van elektromagnetische golven en kunt u zelfs ongelukken veroorzaken.



### VOORZICHTIG

Hiermee wordt gewezen op het risico van letsel.

- Gebruik de flitser niet in de buurt van de ogen.

Dit kan pijn doen aan de ogen.

- De riem is alleen bedoeld voor gebruik op het lichaam. Door de riem met een bevestigd product op te hangen aan een haak of ander object, kan het product beschadigd raken. Schud daarnaast het product niet en stel het product niet bloot aan harde schokken.

● Oefen geen sterke druk uit op de lens en laat geen voorwerpen de lens raken.  
Dit kan letsel of schade aan het product veroorzaken.

- De flitser krijgt een hoge temperatuur wanneer deze flitst. Houd vingers, andere lichaamsdelen en voorwerpen uit de buurt van de flitseenheid terwijl u foto's maakt.

Dit kan brandwonden of een storing van de flitser veroorzaken.







- Laat het product niet achter op plaatsen die worden blootgesteld aan extreem hoge of lage temperaturen.

Het product kan extreem heet/koud worden en brandwonden of letsel veroorzaken wanneer het wordt aangeraakt.

### VOORZICHTIG

Hiermee wordt gewezen op het risico van schade aan eigendommen.

- Richt de camera niet op sterke lichtbronnen, zoals de zon op een heldere dag of een sterke kunstmatige lichtbron.

Als u dit wel doet, kan dit leiden tot schade aan de beeldsensor of andere interne onderdelen.

- Als u de camera gebruikt op een zandstrand of op een winderige plek, dient u erop te letten dat er geen zand of stof in het apparaat terechtkomt.
- Veeg eventueel stof, vuil of ander materiaal dat niet op de flitser thuishoort weg met een wattenstaafje of doek.

De warmte die de flitser produceert, kan ervoor zorgen dat stoffen die niet op de flitser thuishoren rook afgeven. Ook kan de werking van het product verstoord raken.

- Verwijder de accu/accu's en berg deze op wanneer u het product niet gebruikt.

Als de accu lekt kan het product beschadigd worden.

- Breng, voordat u de accu/accu's weggooit, tape of ander isolatiemateriaal aan over de polen van de accu/accu's.



Contact met andere metalen kan leiden tot brand of een explosie.

- Haal een acculader die u voor het product gebruikt uit het stopcontact wanneer deze niet gebruikt wordt. Bedek de lader niet met een doek of andere voorwerpen wanneer deze gebruikt wordt.

Als u de lader gedurende een lange periode in het stopcontact laat, kan deze oververhit en beschadigd raken, waardoor brand kan ontstaan.

- Laat accu's voor het product niet in de buurt van huisdieren liggen.

Als huisdieren op de accu kauwen kan dit leiden tot lekkage, oververhitting of een explosie, met schade aan het product of brand als gevolg.

- Als uw product meerdere accu's gebruikt, dient u geen combinatie van accu's te gebruiken met verschillende spanningsniveaus. Gebruik verder geen oude en nieuwe accu's samen. Let er bij het plaatsen van de accu's op dat u de + en – polen niet verwisselt.

Dit kan de werking van het product negatief beïnvloeden.





# Aan de slag gaan

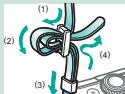

De riem bevestigen

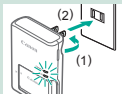

De accu opladen



Een geheugenkaart voorbereiden



De accu plaatsen/verwijderen



Een geheugenkaart plaatsen/verwijderen



De datum en tijd instellen



De weergavetaal instellen



Een lens bevestigen



Een lens verwijderen





EF- en EF-S-lenzen  
bevestigen

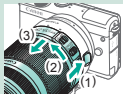

EF- en EF-S-lenzen  
verwijderen



Een statief gebruiken met  
EF- of EF-S-lenzen



Beeldstabilisatie bij  
EF- of EF-S-lenzen gebruiken



De camera vasthouden



# De riem bevestigen

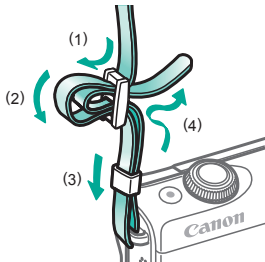

## 1

Verwijder de afdekking van de accu

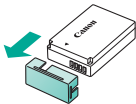

## 2

Plaats de accu



## 3

Laad de accu op



- Aan het opladen: oranje
- Volledig opgeladen: groen





# 4

Verwijder de accu

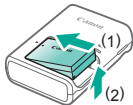



## Een geheugenkaart voorbereiden



Gebruik de volgende geheugenkaarten (afzonderlijk verkrijgbaar) van een willekeurige capaciteit.

- SD-geheugenkaarten\*<sup>1</sup>
- SDHC-geheugenkaarten\*<sup>1\*2</sup>
- SDXC-geheugenkaarten\*<sup>1\*2</sup>



- \*1 Kaarten die voldoen aan de SD-normen. Niet voor alle geheugenkaarten is de werking in deze camera geverifieerd.
- \*2 UHS-I-geheugenkaarten worden ook ondersteund.





# De accu plaatsen/verwijderen



## 1

Open het accuklepje

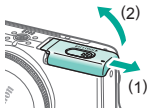

## 2

Bij het plaatsen van de accu:

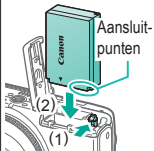

Bij het verwijderen van de accu:

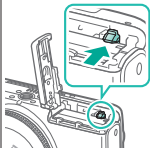

## 3

Sluit het accuklepje

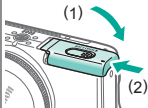



# Een geheugenkaart plaatsen/ verwijderen



1

Open het klepje van de geheugenkaart



2

Bij het plaatsen van de geheugenkaart:



Bij het verwijderen van de geheugenkaart:



3

Sluit het klepje van de geheugenkaart





# De datum en tijd instellen



1

Zet de camera aan



2

Stel de datum en tijd in

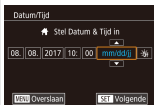

- Gebruik de knoppen om te bladeren → knoppen om aan te passen → knop

3

Stel uw tijdzone thuis in

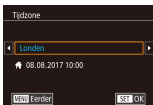

- Gebruik de knoppen om aan te passen → knop



# De weergavetaal instellen



1

Open de  
afspeelmodus



2

Open het  
menuscherm

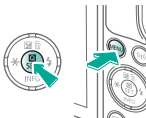

- Houd de knop  ingedrukt en druk op de knop **MENU**.

3

Stel de  
weergavetaal in



- Gebruik de knoppen     om aan te passen → knop .



# Een lens bevestigen



1

Zorg dat de camera is uitgeschakeld



2

Verwijder de lensdop en cameradop

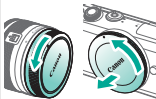

3

Bevestig de lens

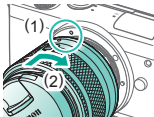

4

Verwijder de voorste lensdop

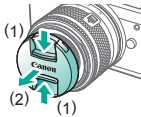

## 5

Bereid de opname voor

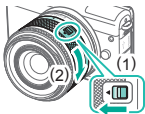

- Druk op (1) terwijl u iets aan (2) draait en laat vervolgens de schakelaar los.

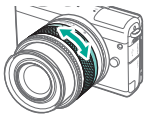

- Zoom in of uit voordat u scherpstelt.



# Een lens verwijderen



1

Zorg dat de camera is uitgeschakeld



2

Verwijder de lens

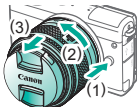

- Druk op (1) terwijl u de lens richting (2) draait totdat deze stopt.
- Verwijder de lens in de getoonde richting (3).

3

Bevestig de lensdop en cameradop





# EF- en EF-S-lenzen bevestigen



1

Zorg dat de camera  
is uitgeschakeld



2

Verwijder de lensdop  
en cameradop

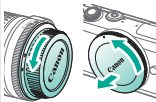

3

Bevestig de adapter  
op de camera



4

Bevestig de lens

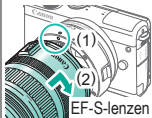
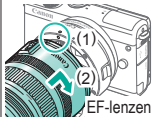





# EF- en EF-S-lenzen verwijderen



1

Zorg dat de camera is uitgeschakeld



2

Verwijder de lens

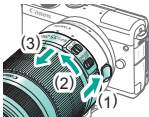

- Verschuif (1) terwijl u de lens richting (2) draait totdat deze stopt.
- Verwijder de lens in de getoonde richting (3).

3

Verwijder de adapter

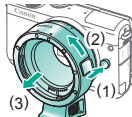

- Druk op (1) terwijl u de adapter richting (2) draait totdat deze stopt.
- Verwijder de adapter in de getoonde richting (3).

4

Bevestig de lensdop en cameradop

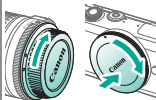



# Een statief gebruiken met EF- of EF-S-lenzen



1

Bevestig de  
statiefvoet aan  
de adapter

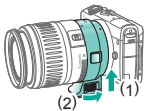

2

Bevestig het statief  
aan de aansluiting  
van de statiefvoet

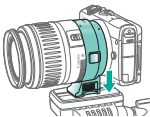



# Beeldstabilisatie bij EF- of EF-S-lenzen gebruiken

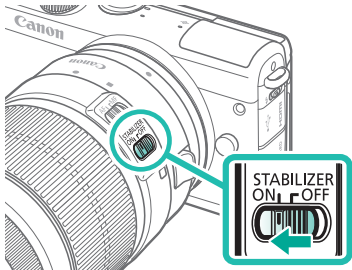



## De camera vasthouden

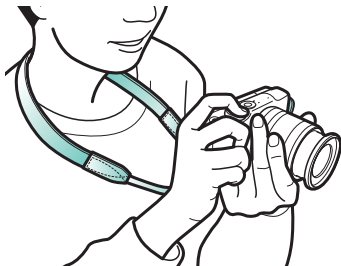



# Basishandelingen van de camera



De camera testen ▶

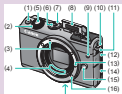

Namen van onderdelen



Aan/uit



Ontspanknop

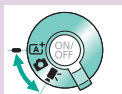

Opnamemodi



De hoek van het scherm  
aanpassen



Kaders op het  
opnamescherm



Opties voor  
opnameweergave



Opties voor  
afspeelweergave





Het scherm Snel instellen  
gebruiken

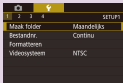

Het menuscherm gebruiken

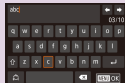

Tekens invoeren



Indicatorweergave



Aanraakbediening 





# Basishandelingen van de camera

## De camera testen



Foto's maken  
(Automatisch/scène)



Films opnemen  
(Automatisch/scène)



Foto's bekijken



Films bekijken



Beelden wissen



# De camera testen

## Foto's maken (Automatisch/scène)



1

Zet de camera aan



2

Stel de modus in



3

Zoom naar  
behoefte in of uit



- (1) Scènepictogram
- (2) Resterend aantal foto's
- (3) Resterende opnametijd







## De camera testen

### Foto's maken (Automatisch/scène)



# 4

### Stel scherp

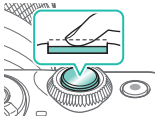

- Druk de ontspanknop lichtjes in.
- De camera piept tweemaal nadat er is scherpgesteld.
- Er wordt een AF-kader weergegeven rond posities waarop is scherpgesteld.

# 5

### Klap indien nodig de flitser uit



- Als [Flitser Opklappen] wordt weergegeven, verschuift u de schakelaar ⚡.

# 6

### Maak de opname





# De camera testen

## Films opnemen (Automatisch/scène)



# 1

Zet de camera aan



# 2

Stel de modus in



# 3

Zoom naar behoefte  
in of uit



- (1) Scènepictogram
- (2) Resterend aantal foto's
- (3) Resterende opnametijd





## De camera testen

### Films opnemen (Automatisch/scène)



# 4

Begin met opnemen

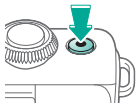

# 5

Stop met opnemen

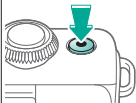

- Er worden kaders weergegeven rond gedetecteerde gezichten waarop is scherpgesteld.





## De camera testen Foto's bekijken



# 1

Open de  
afspeelmodus



# 2

Blader door  
uw beelden



- Knop ◀: vorig beeld
- Knop ▶: volgend beeld



## De camera testen Films bekijken



# 1

Open de  
afspeelmodus



# 2

Blader door  
uw beelden



- Knop ◀: vorig beeld
- Knop ▶: volgend beeld

# 3

Speel de film af



- Films worden aangeduid met [SET ▶].





# De camera testen

## Films bekijken



### 4

Pas het volume aan



● Knoppen ▲/▼ →

[▶] → knop SET





# De camera testen

## Beelden wissen



1

Open de  
afspeelmodus



2

Blader door  
uw beelden



- Knop ◀: vorig beeld
- Knop ▶: volgend beeld

3

Wis



- Knoppen ◀▶ →  
[Wissen] → knop



# Namen van onderdelen

## Voorkant

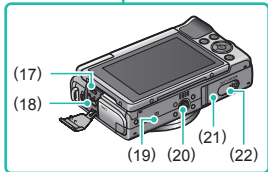
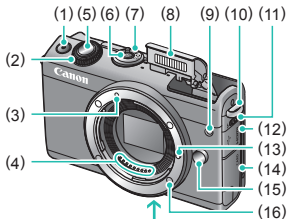

Nr.	Naam	Symbol in deze handleiding
(1)	Filmknop	
(2)	Knop voorkant	
(3)	Markering lensvatting EF-M-lens	
(4)	Contactpunten	
(5)	Ontspanknop	
(6)	ON/OFF-knop	
(7)	Modusschakelaar	
(8)	Flitser	
(9)	Lampje	







## Namen van onderdelen Voorkant

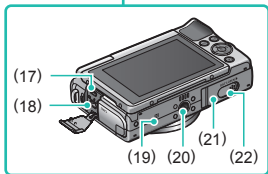
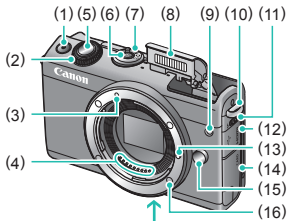

Nr.	Naam	Symbol in deze handleiding
(10)	Bevestigingspunt draagriem	
(11)	Schakelaar voor uitklappen flitser	
(12)	Aansluitingenklepje	
(13)	Lensvergrendelingsstift	
(14)	Klepje van geheugenkaart	
(15)	Lensontgrendelingsknop	
(16)	Lensvatting	



## Namen van onderdelen Voorkant

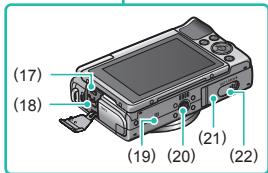
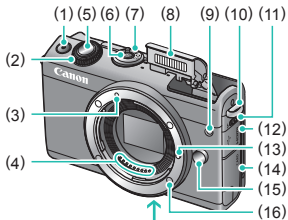

Nr.	Naam	Symbol in deze handleiding
(17)	HDMI™-aansluiting	
(18)	Digital-aansluiting	
(19)	N-markering	
(20)	Statiefbevestiging	
(21)	Accuklepje	
(22)	Aansluitingenklepje DC-koppeling	





## Namen van onderdelen Achterkant

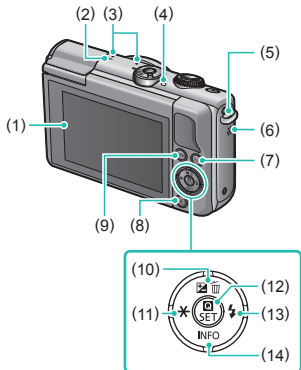

Nr.	Naam	Symbol in deze handleiding
(1)	Schermtouchscreen	
(2)	Scherpstelvlakmarke- ring	
(3)	Microfoon	
(4)	Indicator	
(5)	Bevestigingspunt draagriem	
(6)	Luidspreker	
(7)	Wi-Fi-knop	
(8)	Afspeelknop	





## Namen van onderdelen Achterkant

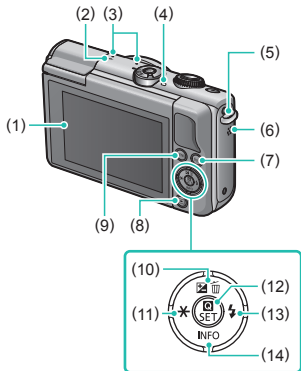

Nr.	Naam	Symbol in deze handleiding
(9)	Menuknop	<b>MENU</b>
(10)	Knop belichtings- compensatie/1 beeld wissen/omhoog	
(11)	Knop AE- vergrendeling/links	
(12)	Knop voor snel instellen/instellen	
(13)	Knop flitser/rechts	
(14)	Knop voor informatie/ omlaag	<b>INFO</b> /





## Namen van onderdelen Lens

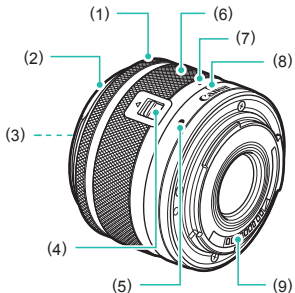

Nr.	Naam	Symbol in deze handleiding
(1)	Scherpstelling	
(2)	Bevestiging zonnekap	
(3)	Filteraansluiting	
(4)	Lensintrekschakelaar	
(5)	Markering lensvatting	
(6)	Zoomring	
(7)	Lensintrekmarkering	
(8)	Zoompositiemarkering	
(9)	Contactpunten	



## Opnamemodus



## Afspeelmodus



- Aan: druk op de knop .
- Uit: druk op de ON/OFF-knop.



# Ontspanknop



1

Druk half in  
(druk lichtjes in om  
scherp te stellen)

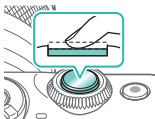

- De camera piept tweemaal.
- Er wordt een kader weergegeven rond posities waarop is scherpgesteld.

2

Druk helemaal in  
(druk de knop, vanaf  
de positie halverwege,  
helemaal in om de  
opname te maken)



- De camera maakt de opname.



# Opnamemodi



Schakel over naar een opnamemodus die past bij het onderwerp of uw manier van opnemen.

- (1) Maak volautomatisch opnemen met door de camera bepaalde instellingen.
- (2) Voeg diverse effecten toe en gebruik de instellingen van uw voorkeur.
- (3) Voor het opnemen van films.

## 1

Stel de modus in



- Verschuif de modusschakelaar.
- Als u  of  kiest, gaat u verder met stap 2.

## 2

Stel de opnamemodus in



- Tik op het pictogram linksboven.

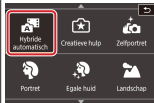



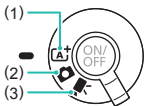

Schakel over naar een opnamemodus die past bij het onderwerp of uw manier van opnemen.

- (1) Maak volautomatisch opnamen met door de camera bepaalde instellingen.
- (2) Voeg diverse effecten toe en gebruik de instellingen van uw voorkeur.
- (3) Voor het opnemen van films.



- Sleep omhoog of omlaag om door verschillende standen te bladeren en tik op de opnamemodus van uw keuze.

## 3

Stel de camera in

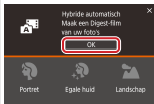

- Tik op [OK].



## De hoek van het scherm aanpassen

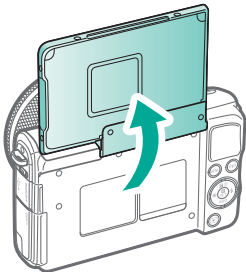

- Het scherm kan tot ongeveer 180 graden worden opengeklapt.



# Kaders op het opnamescherm



## Wit kader



- Wordt weergegeven rond het onderwerp of het gezicht dat als hoofdonderwerp wordt vastgesteld.

## Groen kader



- Wordt weergegeven nadat de camera scherpstelt wanneer u de ontspanknop half indrukt.

## Blauw kader



- Wordt weergegeven terwijl de camera blijft scherpstellen op bewegende onderwerpen in de modus [A+]. Blijft weergegeven worden zolang u de ontspanknop half indrukt.

## Oranje kader + [!]



- Wordt weergegeven als de camera niet kan scherpstellen wanneer u de ontspanknop half indrukt.



# Opties voor opnameweergave



Opname-informatie



Histogram



Geen  
informatieweergave



Scherminfo. Snel  
instellen

## 1

Verander van  
weergavemodus





# Opties voor afspelerweergave



Geen  
informatieweergave



Infoscherm 1  
(overzicht)



Infoscherm 2  
(details)



Infoscherm 3  
(details)

## 1

Verander van  
weergavemodus





## 1

Open het instelscherm



- (1) Instellingsitems
- (2) Instellingsopties

## 2

Kies het item dat u wilt instellen



## 3

Kies de optie die u wilt instellen





## 4

Bevestig uw selectie en sluit af



- Om items in te stellen die worden aangeduid met **[MENU]**, drukt u op de knop **MENU**.





1

Open het menuscherm

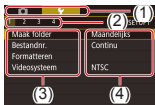
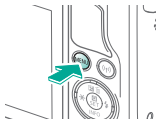

- (1) Functietabbladen
- (2) Paginatabbladen
- (3) Instellingsitems
- (4) Instellingsopties

2

Selecteer een tabblad



3

Kies het item dat u wilt instellen







## 4

Kies de optie die u wilt instellen



## 5

Bevestig uw selectie en sluit af



## Tekens invoeren



- Tik op een teken → [OK]

## Cursor verplaatsen



- Tik op [←]/[→].

## Van invoermodus wisselen

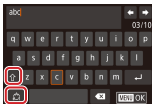

- [123]: schakel over naar cijfers of symbolen
- [⇧]: schakel over naar hoofdletters

## Tekens verwijderen

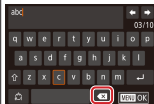

- Tik op [X].





Regeleindes  
invoeren



● Tik op [↵].



Terugkeren naar  
het vorige scherm

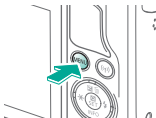



# Indicatorweergave



De indicatorweergave varieert afhankelijk van de status van de camera.

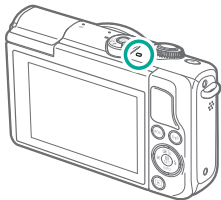

Kleur	Status	Camerastatus
Groen	Knippert langzaam	<ul style="list-style-type: none"><li>● Verbonden met een computer</li><li>● Display uit</li></ul>
	Knippert	<ul style="list-style-type: none"><li>● Aan het opstarten</li><li>● bezig met opnemen op/lezen vanaf een geheugenkaart</li><li>● Aan het communiceren met andere apparaten</li><li>● Opnamen met lange belichtingstijd aan het maken</li><li>● bezig met verbinden/verzenden via Wi-Fi</li></ul>



# Basishandelingen van de camera Aanraakbediening



Scherf Snel instellen

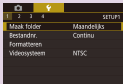

MENU



Afspelen



# Aanraakbediening

## Schermsnel instellen



### Het instelscherm openen



- Tik op **[Q]**.

### De camera instellen



- Tik op een instellingsitem (1) → optie (2).

### Terugkeren naar het vorige scherm



- Tik op **[↶]** of tik nogmaals op het geselecteerde item.

### Van scherm wisselen



- Tik op **[MENU]**.





### Hoeveelheden in balken aanpassen



- Tik op de balk of versleep de balk.





# Aanraakbediening MENU



## De camera instellen

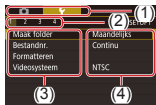

- Tik op een functietabblad (1) →
- paginatablad (2) →
- instellingsitem (3) →
- optie (4).

## Terugkeren naar het vorige scherm

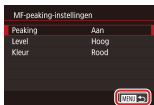

- Tik op **[MENU]**.

## Vinkjes toevoegen/ verwijderen



- Tik op een selectievakje.

## In plaats van de knop **INFO** in te drukken



- Tik op **[INFO]**.







# Aanraakbediening

## MENU



In plaats van  
de knop **MENU**  
in te drukken



- Tik op **[MENU]**.

In plaats van  
de knop **SET**  
in te drukken

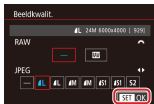

- Tik op **[SET]**.





# Aanraakbediening

## Afspelen



### Afzonderlijke beelden bekijken



- Volgend beeld: sleep naar links
- Vorig beeld: sleep naar rechts

### Films afspelen



- Afspelen: tik op [▶]
- Volume aanpassen: sleep tijdens het afspelen snel omhoog/omlaag

### Bediening tijdens films



- Stoppen: tik op het scherm
- Hervatten: tik op [▶]
- Volume aanpassen: tik op [🔊]

### Overschakelen naar indexweergave





## Aanraakbediening Afspelen



Minder beelden  
weergeven



Beelden vergroten  
(circa 3x)



- Tik snel tweemaal.

Beelden vergroten  
(tot 10x)



Vergrote beelden  
verkleinen



- Oorspronkelijke afmetingen herstellen:  
tik op **[MENU]**





# Opnamen maken



Op basis van een voorbeeld	Auto-modus	Specifieke scènes
Beeldeffecten (Creatieve filters)	Handmatige modus	Films opnemen in de filmmodus
Handige functies		



Zelfportretten met optimale instellingen



Portretten



Egale huid



Landschappen



Close-ups



Bewegende onderwerpen





# Opnamen maken



Op basis van een voorbeeld	Auto-modus	Specifieke scènes
Beeldeffecten (Creatieve filters)	Handmatige modus	Films opnemen in de filmmodus
Handige functies		



Kleuren verbeteren van voedsel



Avondcomposities zonder statief



Opnamen met tegenlicht



Monochroom



Softfocuseffect



Visooglenseffect



## Opnamen maken



Op basis van een voorbeeld	Auto-modus	Specifieke scènes
Beeldeffecten (Creatieve filters)	Handmatige modus	Films opnemen in de filmmodus
Handige functies		



Olieverfschilderijeffect



Aquareffect



Speelgoedcameraeffect



Miniatuurmodeffect



Opnamen met veel contrast



# Opnamen maken



Op basis van een voorbeeld	Auto-modus	Specifieke scènes
Beeldeffecten (Creatieve filters)	Handmatige modus	Films opnemen in de filmmodus
Handige functies		



Automatisch/scène (Foto's)



Automatisch/scène (Films)



Modus Hybride automatisch



# Automatisch/scène (Foto's)



1

Zet de camera aan



2

Stel de modus in



3

Zoom naar  
behoefte in of uit



4

Maak de opname







## Automatisch/scène (Films)



1

Zet de camera aan



2

Stel de modus in



3

Zoom naar  
behoefte in of uit



4

Begin met  
opnemen

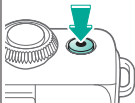



5

Pas de compositie van de opname aan uw wensen aan



6

Stop met opnemen

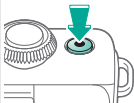



# Modus Hybride automatisch



U kunt eenvoudig een korte film van de dag maken door foto's te maken. De camera neemt voor elke opname clips van 2–4 seconden op van scènes, die later worden gecombineerd in een digest-film.

1

Stel de modus in



2

Stel de opname-modus in

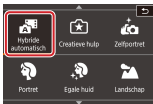

• [A] → [OK]

3

Kies de compositie en maak een opname





# Opnamen maken



Op basis van een voorbeeld	Auto-modus	Specifieke scènes
Beeldeffecten (Creatieve filters)	Handmatige modus	Films opnemen in de filmmodus
Handige functies		



Zelfportretten met optimale instellingen



Portretten



Egale huid



Landschappen



Close-ups



Bewegende onderwerpen





# Opnamen maken



Op basis van een voorbeeld	Auto-modus	Specifieke scènes
Beeldeffecten (Creatieve filters)	Handmatige modus	Films opnemen in de filmmodus
Handige functies		



Kleuren verbeteren van voedsel



Avondcomposities zonder statief



Opnamen met tegenlicht





# Zelfportretten met optimale instellingen



 Zelfportret

Bij het maken van zelfportretten kunt u diverse beeldverwerkingsinstellingen aanpassen. Zo kunt u uw huid egaler laten lijken op het beeld of de helderheid en de achtergrond aanpassen zodat u beter opvalt.

1

Open het scherm

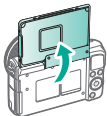

2

Stel de opname-modus in



- Tik op .

3

Stel de camera in

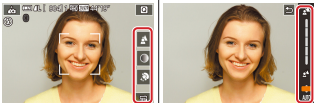

- Pas het niveau aan.





 Zelfportret

Bij het maken van zelfportretten kunt u diverse beeldverwerkingsinstellingen aanpassen. Zo kunt u uw huid egaler laten lijken op het beeld of de helderheid en de achtergrond aanpassen zodat u beter opvalt.

---

# 4

Maak de opname





# Portretten



 Portret

Mensen fotograferen met een verzachtend effect.

1

Stel de modus in



2

Stel de opname-modus in

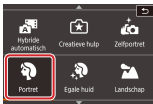

●  → [OK]

3

Maak de opname







# Egale huid



 Egale huid

Verwerk beelden om de huid er egaler te laten uitzien.

1

Stel de modus in



2

Stel de opname-  
modus in



● [] → [OK]

3

Maak de opname





# Landschappen



 Landschap

Leg weidse landschappen of vergelijkbare scènes scherp vast, van de voorgrond tot aan de horizon, waarbij blauwe lichten en het groen in levendige tinten worden gereproduceerd.

1

Stel de modus in



2

Stel de opname-modus in

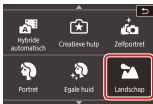

●  → [OK]

3

Maak de opname





# Close-ups



 Close-up

Maak close-ups van bloemen of andere kleine voorwerpen.

1

Stel de modus in



2

Stel de opname-modus in

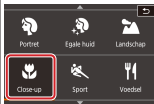

●  → [OK]

3

Maak de opname





# Bewegende onderwerpen



 Sport

Maak continu opnamen terwijl de camera op het onderwerp blijft scherpstellen.

1

Stel de modus in



2

Stel de opname-modus in

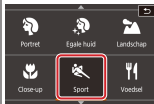

●  → [OK]

3

Maak de opname





# Kleuren verbeteren van voedsel



 Voedsel

Pas de kleurtonen aan om voedsel er vers en kleurrijk uit te laten zien.

1

Stel de modus in



2

Stel de opname-modus in

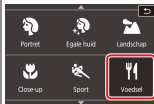

●  → [OK]

3

Pas de kleurtoon aan

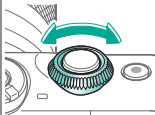



Voedsel

Pas de kleurtonen aan om voedsel er vers en kleurrijk uit te laten zien.

## 4

Maak de opname





# Avondcomposities zonder statief



Nachtopnamen  
uit hand

Fraaie opnamen van composities of portretten in avondlicht, zonder dat u de camera heel stil hoeft te houden (zoals met een statief).

1

Stel de modus in



2

Stel de opname-  
modus in



● [Nacht opnam. uit hand] → [OK]

3

Maak de opname





# Opnamen met tegenlicht



 HDR-tegenlicht

Steeds als u een opname maakt, worden drie opeenvolgende beelden met verschillende helderheidsniveaus gemaakt, en de camera combineert vervolgens de beeldgebieden met optimale helderheid tot één beeld. Deze modus vermindert het verlies van details in schaduwgebieden, wat vaak voorkomt bij opnamen met gemengde heldere en donkere beeldgebieden.

1

Stel de modus in



2

Stel de opname-modus in



● [HDR-contrast] → [OK]

3

Maak de opname







# Opnamen maken



Op basis van een voorbeeld	Auto-modus	Specifieke scènes
Beeldeffecten (Creatieve filters)	Handmatige modus	Films opnemen in de filmmodus
Handige functies		



Monochroom



Softfocuseffect



Visooglenseffect



Olieverfschilderijeffect



Aquareleffect



Speelgoedcameraeffect





## Opnamen maken



Op basis van een voorbeeld	Auto-modus	Specifieke scènes
Beeldeffecten (Creatieve filters)	Handmatige modus	Films opnemen in de filmmodus
Handige functies		



Miniatuurmodeffect



Opnamen met veel contrast



HDR-effect





# Monochroom



 Korrelig Z/W

Maak monochroomfoto's met een gruisige, ruwe uitstraling.

1

Stel de modus in



2

Stel de opname-modus in



●  → [OK]

3

Pas het effectniveau aan

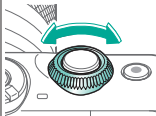



## Monochroom



 Korrelij Z/W

Maak monochroomfoto's met een gruisige, ruwe uitstraling.

---

# 4

Maak de opname





# Softfocuseffect



Normaal



 Softfocus

Met deze functie kunt u opnamen maken alsof er een softfocusfilter op de camera is gemonteerd.

1

Stel de modus in



2

Stel de opname-modus in



•  → [OK]

3

Pas het effectniveau aan

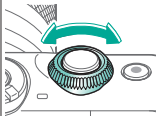



## Softfocuseffect



Normaal



 Softfocus

Met deze functie kunt u opnamen maken alsof er een softfocusfilter op de camera is gemonteerd.

---

# 4

Maak de opname





# Visooglenseffect



 Fisheye-effect

Opnamen maken met het vervormende effect van een visooglens.

1

Stel de modus in



2

Stel de opname-  
modus in



•  → [OK]

3

Pas het effectniveau  
aan

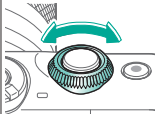



 Fisheye-effect

Opnamen maken met het vervormende effect van een visooglens.

---

## 4

Maak de opname







# Olieverfschilderijeffect



 Effect kunst opvallend

Geef onderwerpen een meer solide uitstraling, net als onderwerpen in olieverfschilderijen.

1

Stel de modus in



2

Stel de opname-modus in



●  → [OK]

3

Pas het effectniveau aan

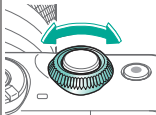



 Effect kunst  
opvallend

Geef onderwerpen een meer solide uitstraling, net als onderwerpen in olieverfschilderijen.

---

## 4

Maak de opname





# Aquareleffect



 Aquareleffect

Maak de kleuren zachter, voor foto's die op aquarellen lijken.

1

Stel de modus in



2

Stel de opname-modus in



●  → [OK]

3

Pas het effectniveau aan

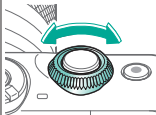



## Aquareleffect



 Aquareleffect

Maak de kleuren zachter, voor foto's die op aquarellen lijken.

---

# 4

Maak de opname





# Speelgoedcameraeffect



 Speelgoed-camera-effect

Met dit effect lijkt het alsof het beeld is gemaakt met een speelgoedcamera, met vignettering (donkerder, vage hoeken) en een aanpassing van de algehele kleur.

1

Stel de modus in



2

Stel de opname-modus in



 → [OK]

3

Kies een effect

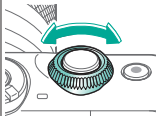



## Speelgoedcameraeffect



 Speelgoed-camera-effect

Met dit effect lijkt het alsof het beeld is gemaakt met een speelgoedcamera, met vignettering (donkerder, vage hoeken) en een aanpassing van de algehele kleur.

---

# 4

Maak de opname





# Miniatuurmodeleffect



 Miniatuureffect

Geeft het effect van een miniatuurmodel door beeldgebieden buiten een geselecteerd gebied te vervagen.

1

Stel de modus in



2

Stel de opname-modus in



●  → [OK]

3

Kies het gebied waarop u wilt scherpstellen





## Miniatuurmodeffect



 Miniatureffect

Geeft het effect van een miniatuurmodel door beeldgebieden buiten een geselecteerd gebied te vervagen.



- Om de afmetingen van het kader te veranderen: 



- Om het kader te verplaatsen: knoppen  

### 4

Kies voor films de snelheid

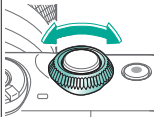

### 5

Keer terug naar het opnamescherm







 Miniatureffect

Geeft het effect van een miniatuurmodel door beeldgebieden buiten een geselecteerd gebied te vervagen.

---

# 6

Maak de opname





# Opnamen met veel contrast



Normaal



HDR

Steeds als u een opname maakt, worden drie opeenvolgende beelden met verschillende helderheidsniveaus gemaakt. De camera combineert vervolgens de beeldgebieden met optimale helderheid tot één beeld (High Dynamic Range). Deze modus vermindert de vervaagde highlights en het verlies van details in schaduwgebieden die vaak voorkomen bij opnamen met veel contrast.

1

Stel de modus in



2

Stel de opname-modus in

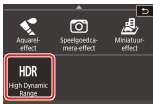

• [HDR] → [OK]

3

Maak de opname





# HDR-effect



Natuurlijk



Kunst



Kunst helder



Kunst olieverf

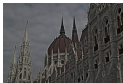

Kunst embosseren  
(reliëf)

1

Stel de modus in



2

Stel de opname-  
modus in

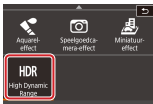

● **[HDR]** → [OK]

3

Kies een effect

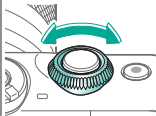



## HDR-effect



Natuurlijk



Kunst



Kunst helder



Kunst olieverf

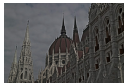

Kunst embosseren  
(reliëf)

---

# 4

Maak de opname





# Opnamen maken



Op basis van een voorbeeld	Auto-modus	Specifieke scènes
Beeldeffecten (Creatieve filters)	<b>Handmatige modus</b>	Films opnemen in de filmmodus
Handige functies		



Opnamen maken vanaf één scherm instellen



Scherpstellen >



Beeldhelderheid >



Flitser >



Beeldkleuren >



Overige instellingen >





# Opnamen maken



Op basis van een voorbeeld	Auto-modus	Specifieke scènes
Beeldeffecten (Creatieve filters)	<b>Handmatige modus</b>	Films opnemen in de filmmodus
Handige functies		



Specifieke sluitertijden  
en diafragmawaarden ➤



De camera aanpassen ➤



Creatieve hulp ➤



# Opnamen maken vanaf één scherm instellen



Via het scherm INFO. Snel instellen kunt u eenvoudig een aantal verschillende opname-instellingen openen in een enkel scherm.

## 1

Open het instelscherm



- Druk een paar keer op de knop ▼.

## 2

Selecteer een instelling om te configureren



- Druk op de knop

- Gebruik de knoppen ▲/▼/◀/▶ om te bladeren → knop om aan te passen



# Opnamen maken

## Beeldhelderheid



Op basis van een voorbeeld	Auto-modus	Specifieke scènes
Beeldeffecten (Creatieve filters)	<b>Handmatige modus</b>	Films opnemen in de filmmodus
Handige functies		



De helderheid van het beeld  
aanpassen (Belichtingscompensatie)



De meetmethode wijzigen



Belichtingssimulatie uitschakelen



De ISO-snelheid wijzigen



Belichting en helderheid van beeld  
vergrendelen (AE-vergrendeling)

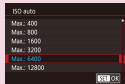

Aanpassen van automatische  
instellingen voor ISO







# Opnamen maken

## Beeldhelderheid



Op basis van een voorbeeld	Auto-modus	Specifieke scènes
Beeldeffecten (Creatieve filters)	<b>Handmatige modus</b>	Films opnemen in de filmmodus
Handige functies		



Helderheid en contrast automatisch corrigeren (Automatische helderheidsoptimalisatie)



Opnamen maken van heldere onderwerpen (Lichte tonen prioriteit)





# De helderheid van het beeld aanpassen (Belichtingscompensatie)



Stel in richting -



±0



Stel in richting +

De standaardbelichting kan worden aangepast in stappen van 1/3 stop, in een bereik van -3 tot +3.

## 1

Open de belichtingscompensatiebalk



## 2

Stel de camera in



- Draai de knop  terwijl u naar het scherm kijkt → knop 



# Belichtingssimulatie uitschakelen



Beelden worden weergegeven met een helderheid die de daadwerkelijke helderheid simuleert zoals deze wordt vastgelegd. Daarom wordt ook de schermhelderheid aangepast aan wijzigingen in de belichtingscompensatie. Deze functie kan worden uitgeschakeld om het scherm op een helderheid te houden die handig is voor opnamen, zonder invloed van de belichtingscompensatie.

1

Open het  
menuschermb

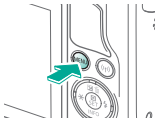

2

Stel de camera in



- [Camera icon] 1 → [Bel. simulatie] → [Uitsch.]



# Belichting en helderheid van beeld vergrendelen (AE-vergrendeling)



Zonder AE-  
vergrendeling



AE-vergrendeling

Voordat u een opname maakt, kunt u de belichting vergrendelen, of u kunt de focus en belichting afzonderlijk instellen.

## 1

Vergrendel de belichting



- Richt de camera met vergrendelde belichting op het onderwerp waarvan u een opname wilt maken en druk op de knop ◀.

## 2

Kies de compositie en maak een opname





# De meetmethode wijzigen

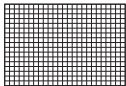

Meervlaks meting



Deelmeting



Spotmeting



Centrum gewogen  
gemiddeld

1

Open het  
instelscherm



2

Stel de camera in



- → kies een optie → knop



# De ISO-snelheid wijzigen



Zwak



Sterk

Stel de ISO-snelheid in op [AUTO] voor automatische aanpassing aan de opnamemodus en opnameomstandigheden. U kunt ook een hogere ISO-snelheid instellen voor hogere gevoeligheid of een lagere waarde voor lagere gevoeligheid.

1

Open de ISO-snelheidsbalk



- Tik op **[ISO AUTO]**.

2

Stel de camera in



- Knoppen  → knop 



# Aanpassen van automatische instellingen voor ISO



Maximum laag ingesteld



Maximum hoog ingesteld

U kunt de ISO-snelheid beperken wanneer de ISO-snelheid is ingesteld op [AUTO].

1

Open het menuscherm

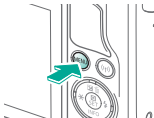

2

Stel de camera in



- [CAMERA] → [ISO-snelheid] → [ISO auto] → kies een optie → knop



# Helderheid en contrast automatisch corrigeren (Automatische helderheidsoptimalisatie)



Uitschakelen



Zwak



Standaard



Hoog

1

Open het  
instelscherm



2

Stel de camera in



- [Icon] → kies een optie → knop [SET]





# Opnamen maken van heldere onderwerpen (Lichte tonen prioriteit)



Verbeter de gradatie in heldere beeldgebieden om te voorkomen dat details verloren gaan in de lichte tonen van het onderwerp.

1

Open het  
menuscherm

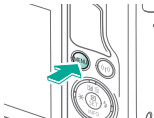

2

Stel de camera in

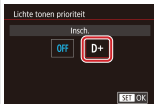

- [CAMERA] → [Lichte tonen prioriteit] → [Insch.] → knop [SET]



# Opnamen maken

## Beeldkleuren



Op basis van een voorbeeld	Auto-modus	Specifieke scènes
Beeldeffecten (Creatieve filters)	<b>Handmatige modus</b>	Films opnemen in de filmmodus
Handige functies		



Natuurlijke kleuren vastleggen  
(Witbalans)



Handmatige witbalans



De witbalans handmatig  
corrigeren



Witbalanskleurtemperatuur  
handmatig instellen



Kleurtonen kiezen (Beeldstijl)



Beeldstijlen aanpassen





# Opnamen maken

## Beeldkleuren



Op basis van een voorbeeld	Auto-modus	Specifieke scènes
Beeldeffecten (Creatieve filters)	Handmatige modus	Films opnemen in de filmmodus
Handige functies		



Aangepaste beeldstijlen  
opslaan





# Natuurlijke kleuren vastleggen (Witbalans)



Daglicht



Bewolkt



Kunstlicht

Door de witbalans aan te passen kunt u beeldkleuren natuurlijker laten lijken voor de compositie waarvan u een opname maakt.

1

Open het instelscherm



2

Stel de camera in



- **[WB]** → kies een optie → knop **[SET]**



# Handmatige witbalans



Wit laden

Pas de witbalans aan de lichtbron aan terwijl u opnamen maakt voor beeldkleuren die natuurlijk lijken in het licht van uw opname. Stel de witbalans in onder dezelfde lichtbron die uw opname zal verlichten.

1

Fotografeer een wit voorwerp



- Breng een effen wit voorwerp schermvullend in beeld, stel scherp en maak de opname.

2

Open het menuscherm

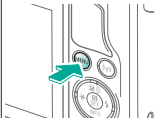

3

Open het scherm Handmatige WB

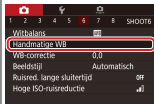

- [CAMERA] → [Handmatige WB] → knop [SET]





## Handmatige witbalans



Wit laden

Pas de witbalans aan de lichtbron aan terwijl u opnamen maakt voor beeldkleuren die natuurlijk lijken in het licht van uw opname. Stel de witbalans in onder dezelfde lichtbron die uw opname zal verlichten.

### 4

Laad de witbalansgegevens



- Selecteer uw beeld uit stap 1 → knop → [OK] → knop

### 5

Keer terug naar het opnamescherm

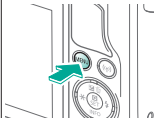

### 6

Open het instelscherm





Wit laden

Pas de witbalans aan de lichtbron aan terwijl u opnamen maakt voor beeldkleuren die natuurlijk lijken in het licht van uw opname. Stel de witbalans in onder dezelfde lichtbron die uw opname zal verlichten.

---

## 7

Stel de camera in





# De witbalans handmatig corrigeren



Daglichtopname



Gecorrigeerd

U kunt de witbalans handmatig aanpassen. Deze aanpassing kan overeenkomen met effect dat u zou krijgen bij gebruik van een in de winkel verkrijgbaar kleurtemperatuurconversiefilter of kleurcompensatiefilter.

1

Open het instelscherm



2

Stel de camera in



- **[WB]** → kies een optie → knop om aan te passen

3

Verfijn de instelling indien nodig

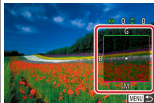





## De witbalans handmatig corrigeren



Daglichtopname



Gecorrigeerd

U kunt de witbalans handmatig aanpassen. Deze aanpassing kan overeenkomen met effect dat u zou krijgen bij gebruik van een in de winkel verkrijgbaar kleurtemperatuurconversiefilter of kleurcompensatiefilter.



- Knop **MENU** →  
knoppen ▲/▼/◀▶  
om aan te passen →  
knop **MENU**



# Witbalanskleurtemperatuur handmatig instellen



Er kan een waarde worden ingesteld die de witbalanskleurtemperatuur vertegenwoordigt.

1

Open het  
instelscherm



2

Kies het item dat  
u wilt instellen



● [AVB] → [K] →  
[5200K]

3

Stel de camera in



● Kies een optie →  
knop [SET]



# Kleurtonen kiezen (Beeldstijl)



Standaard



Landschap

Selecteer een Beeldstijl met kleurinstellingen die goed de stemmingen of onderwerpen uitdrukt. Er zijn acht Beeldstijlen beschikbaar en elke beeldstijl kan verder worden aangepast.

1

Open het instelscherm



2

Stel de camera in

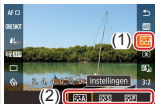

- → kies een optie → knop



# Beeldstijlen aanpassen



Pas parameters van beeldstijlen zoals contrast of verzadiging aan.

1

Open het instelscherm



2

Kies een stijl

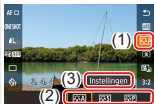

-  → kies een optie → [Instellingen]

3

Stel de camera in



- Selecteer een item → pas aan → knop 



# Aangepaste beeldstijlen opslaan



Sla vooraf ingestelde opties (zoals of ) op die u hebt aangepast als nieuwe stijlen. U kunt meerdere beeldstijlen maken met verschillende instellingen voor parameters zoals scherpte of contrast.

1

Open het  
instelscherm



2

Selecteer een door de  
gebruiker gedefinieerd  
stijlnummer

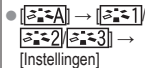

3

Selecteer een stijl  
om te bewerken





Sla vooraf ingestelde opties (zoals of ) op die u hebt aangepast als nieuwe stijlen. U kunt meerdere beeldstijlen maken met verschillende instellingen voor parameters zoals scherpte of contrast.

## 4

Pas de stijl aan



- Gebruik de knoppen / om een optie om te bewerken te kiezen → knoppen / om aan te passen → knop



## Opnamen maken Scherpstellen



Op basis van een voorbeeld	Auto-modus	Specifieke scènes
Beeldeffecten (Creatieve filters)	<b>Handmatige modus</b>	Films opnemen in de filmmodus
Handige functies		



Opnamen maken in de modus  
Handmatig scherpstellen



De scherpstelling verfijnen



Het scherpstelgebied eenvoudig  
bepalen (MF-peaking)



De AF-methode selecteren



Opnamen maken met Servo AF



De scherpstellingsinstelling  
veranderen





## Opnamen maken Scherpstellen



Op basis van een voorbeeld	Auto-modus	Specifieke scènes
Beeldeffecten (Creatieve filters)	Handmatige modus	Films opnemen in de filmmodus
Handige functies		



Onderwerpen kiezen om op  
scherp te stellen (Touch AF)







# Opnamen maken in de modus Handmatig scherpstellen



Gebruik handmatig scherpstellen wanneer scherpstellen in de AF-modus niet mogelijk is. Vergroot de weergave om het scherpstellen makkelijker te maken.

# 1

Selecteer **[MF]**  
(EF-M-lenzen)

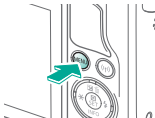

- [CAMERA] →  
[Scherpstelmodus] →  
[MF] → knop →  
knop **MENU**

(Andere lenzen)

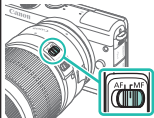

- Stel de lensschakelaar in op MF.





## Opnamen maken in de modus Handmatig scherpstellen



Gebruik handmatig scherpstellen wanneer scherpstellen in de AF-modus niet mogelijk is. Vergroot de weergave om het scherpstellen makkelijker te maken.

### 2

Activeer de vergroting



- Tik op [Q].

### 3

Selecteer een gebied waarop u wilt scherpstellen



- Sleep over het scherm om een gebied weer te geven waarop u wilt scherpstellen.
- Om het midden van het beeld weer te geven, drukt u op de knop ▼.

### 4

Stel scherp





## Opnamen maken in de modus Handmatig scherpstellen



Gebruik handmatig scherpstellen wanneer scherpstellen in de AF-modus niet mogelijk is. Vergroot de weergave om het scherpstellen makkelijker te maken.

---

# 5

Maak de opname





# De scherpstelling verfijnen



Automatische  
scherpstelling



Scherpstelling

Verfijn de automatische scherpstelling bij een gekoppelde EF-M-lens door aan de scherpstelling te draaien.

1

Open het  
menuscherp

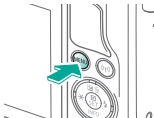

2

Stel de camera in



- [Camera icon] 3 →  
[Scherpstelmodus] →  
[AF+MF] → knop [SET]

3

Stel scherp

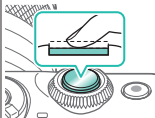

- Houd de ontspanknop  
half ingedrukt.





## De scherpstelling verfijnen



Automatische  
scherpstelling



Scherpstelling

Verfijn de automatische scherpstelling bij een gekoppelde EF-M-lens door aan de scherpstelring te draaien.

### 4

Verfijn de  
scherpstelling



- Vergroting wordt geactiveerd.

### 5

Maak de opname

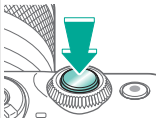



# Het scherpstelgebied eenvoudig bepalen (MF-peaking)



MF-peaking uit



MF-peaking aan

Randen van onderwerpen waarop is scherpgesteld worden in kleur weergegeven om handmatig scherpstellen te vereenvoudigen. U kunt de kleuren en de gevoeligheid (niveau) van de randdetectie aanpassen.

1

Open het  
menuschermb

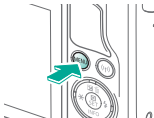

2

Stel de camera in



- [CAMERA] → [MF-peaking-instellingen] → [Peaking] → [Aan]

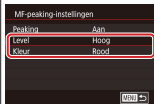



## Het scherpstelgebied eenvoudig bepalen (MF-peaking)



MF-peaking uit



MF-peaking aan

Randen van onderwerpen waarop is scherpgesteld worden in kleur weergegeven om handmatig scherpstellen te vereenvoudigen. U kunt de kleuren en de gevoeligheid (niveau) van de randdetectie aanpassen.



- Gebruik de knoppen ▲/▼ om te bladeren  
→ knoppen ▲/▼ om aan te passen



# De AF-methode selecteren



Eén punt AF



+volgen



Soepele zone AF

Pas de modus voor automatische scherpstelling (AF) aan de opnameomstandigheden aan.

1

Open het instelscherm



2

Stel de camera in



- [AF □] → kies een optie → knop





# Opnamen maken met Servo AF



Deze modus helpt u om te voorkomen dat u foto's mist van bewegende onderwerpen, omdat de camera blijft scherpstellen op het onderwerp en de belichting aanpast zolang u de ontspanknop half ingedrukt houdt.

1

Open het instelscherm



2

Stel de camera in



• [ONE SHOT] →  
[SERVO] → knop 

3

Stel scherp

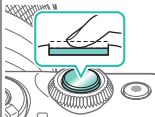



Deze modus helpt u om te voorkomen dat u foto's mist van bewegende onderwerpen, omdat de camera blijft scherpstellen op het onderwerp en de belichting aanpast zolang u de ontspanknop half ingedrukt houdt.

---

## 4

Maak de opname





# De scherpstellingsinstelling veranderen



Inschakelen: stel scherp op bewegende onderwerpen



Uitschakelen: stel scherp op stilstaande onderwerpen

U kunt de standaardwaarden van de camera zo instellen dat deze constant scherpstelt op de onderwerpen waarop deze wordt gericht, zelfs wanneer de ontspanknop niet wordt ingedrukt. U kunt in plaats hiervan de camera beperken tot scherpstellen op het moment waarop u de ontspanknop half indrukt.

## 1

Open het  
menuscherf

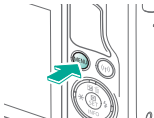

## 2

Stel de camera in



● [Camera] → [Continu] →  
[Uitsch.]



# Onderwerpen kiezen om op scherp te stellen (Touch AF)



AF □



AF ☺

U kunt een opname maken nadat de camera heeft scherpgesteld op het onderwerp, het gezicht of de positie op het scherm.

1

Tik op een onderwerp waarop u wilt scherpstellen



2

Maak de opname

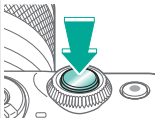



# Opnamen maken Flitser



Op basis van een voorbeeld	Auto-modus	Specifieke scènes
Beeldeffecten (Creatieve filters)	<b>Handmatige modus</b>	Films opnemen in de filmmodus
Handige functies		



De flitsmodus wijzigen



De flitsbelichtingscompensatie  
aanpassen



Opnamen maken met  
FE-vergrendeling



De flitstiming wijzigen

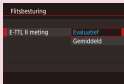

De flitsmeetmethode wijzigen



De flitsoutput aanpassen





# Opnamen maken

## Flitser



Op basis van een voorbeeld	Auto-modus	Specifieke scènes
Beeldeffecten (Creatieve filters)	Handmatige modus	Films opnemen in de filmmodus
Handige functies		

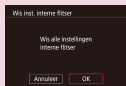

Flitsinstellingen resetten





# De flitsmodus wijzigen



U kunt de flitsmodus wijzigen en aanpassen aan de opnamecompositie.  
Om het hoofdonderwerp (bijvoorbeeld mensen) te verlichten en schaduwen op de achtergrond te beperken, gebruikt u Slow sync.

1

Klap de flitser uit



2

Stel de camera in

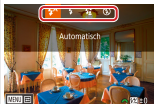

- Knop ► → kies een flitsmodus → knop (SET)



# De flitsbelichtingscompensatie aanpassen



Stel in richting -



Stel in richting +

Net als bij de normale belichtingscompensatie kunt u de flitsbelichting aanpassen met stappen van 1/3 stop in een bereik van -2 tot +2.

## 1

Klap de flitser uit



## 2

Stel de camera in

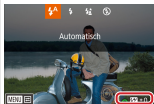

- Knop → knop om aan te passen → knop





# Opnamen maken met FE-vergrendeling



FE-lock



Zonder FE-vergrendeling (overbelicht)

Net als bij de AE-vergrendeling kunt u de belichting vergrendelen voor opnamen met de flitser.

1

Klap de flitser uit



2

Ingesteld op [⚡]

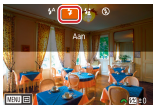

● Knop ► → [⚡]

3

Vergrendel de  
flitsbelichting



- Richt op onderwerp voor vaste belichting → knop ◀





FE-lock



Zonder FE-vergrendeling (overbelicht)

Net als bij de AE-vergrendeling kunt u de belichting vergrendelen voor opnamen met de flitser.

## 4

Kies de compositie en maak een opname





# De flitstiming wijzigen



Flitser 1e gordijn



Flitser 2e gordijn

Wijzig de timing van de flitser en de sluitser.

1

Open het  
menuscherm



2

Stel de camera in

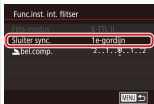

- [CAMERA] →  
[Flitsbesturing] →  
[Func.inst. int. flitser]  
→ [Sluiter sync.] →  
kies een optie



# De flitsmeetmethode wijzigen

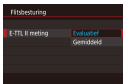

Evaluatief

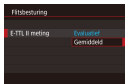

Gemiddeld

De flitslichtmeting [Evaluatief], waarmee standaardflitsbelichting wordt ingeschakeld, kan worden gewijzigd naar gemiddelde flitslichtmeting over het meetgebied, zoals wanneer een extern gemeten flitser wordt gebruikt.

1

Open het  
menuschermb

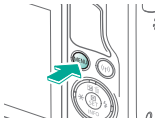

2

Stel de camera in

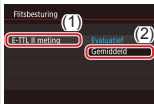

- [CAMERA] →  
[Flitsbesturing] →  
[E-TTL II meting] →  
[Gemiddeld] →  
knop [SET]



# De flitsoutput aanpassen



: minimaal



: maximaal

Maak een keuze uit de drie flitsniveaus in de standen **[M/Av/Tv]**.

1

Stel de modus in



2

Stel de opname-modus in



● **[M/Av/Tv]** →  
[OK]

3

Open het menuscherm





## De flitsoutput aanpassen



: minimaal



: maximaal

Maak een keuze uit de drie flitsniveaus in de standen **[M/Av/Tv]**.

### 4

Stel de camera in

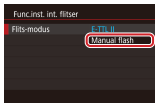

- [5] →  
[Flitsbesturing] →  
[Func.inst. int. flitser]  
→ [Flits-modus] →  
[Manual flash] →  
knop **MENU**

### 5

Klap de flitser uit



### 6

Pas de flitsoutput aan





## De flitsoutput aanpassen



: minimaal



: maximaal

Maak een keuze uit de drie flitsniveaus in de standen **[M/Av/Tv]**.



- Knop → knop om aan te passen → knop



# Flitsinstellingen resetten



1

Open het  
menuscherm

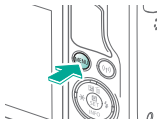

2

Herstel de stan-  
daardinstellingen



- [CAMERA] →  
[Flitsbesturing] →  
[Wis instellingen]



- [OK] → knop [SET]





# Opnamen maken

## Overige instellingen



Op basis van een voorbeeld	Auto-modus	Specifieke scènes
Beeldeffecten (Creatieve filters)	<b>Handmatige modus</b>	Films opnemen in de filmmodus
Handige functies		



Instellingen van de IS-modus wijzigen



Cameratrilling corrigeren tijdens het opnemen van films



Lensafwijkingen corrigeren



Het ruisreductieniveau wijzigen



Ruisonderdrukking bij meerdere opnamen



Ruis onderdrukken bij lange sluitertijden



# Instellingen van de IS-modus wijzigen



Continu



Uit

Configureer de beeldstabilisatie via het cameramenu wanneer u een EF-M-lens met beeldstabilisatie gebruikt.

1

Open het  
menuschermb

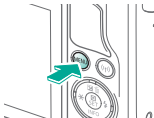

2

Stel de camera in



- [CAMERA] →  
[IS-instellingen] →  
[IS modus] →  
kies een optie



# Cameratrilling corrigeren tijdens het opnemen van films



Inschakelen



Uitschakelen

Activeer beeldstabilisatie op de camera om cameratrillingen tijdens filmopnamen te corrigeren met een lens die beeldstabilisatie ondersteunt.

1

Open het menuscherm

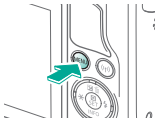

2

Stel de camera in



- [CAMERA] → [IS-instellingen] → [Digitale IS] → kies een optie



# Lensafwijkingen corrigeren



Correctie helderheid randen: uitschakelen



Correctie helderheid randen: inschakelen

Corrigeer vignettering en randverkleuring van onderwerpen door kenmerken van de lens of een gebrek aan scherpte door het diafragma.

## 1

Open het menuscherm

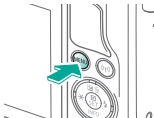

## 2

Stel de camera in

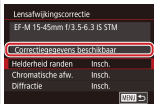

- [CAMERA] → [Lensafwijkingcorrectie] → kies een optie
- Bevestig dat [Correctiegegevens beschikbaar] wordt weergegeven.

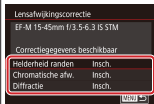

- Kies een optie → knop



# Het ruisreductieniveau wijzigen



U kunt uit 3 niveaus van ruisreductie kiezen: [Standaard], [Sterk], [Zwak]. Deze functie is met name effectief bij het maken van opnamen met hoge ISO-snelheden.

1

Open het  
menuschermb

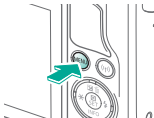

2

Stel de camera in



- [camera icon] → [Hoge ISO-ruisreductie] → kies een optie → knop [SET]



# Ruisonderdrukking bij meerdere opnamen



Combineer automatisch vier beelden die in één keer worden vastgelegd om beeldruis te beperken. Dit maakt een hogere beeldkwaliteit mogelijk dan [Hoge ISO-ruisreductie] instellen op [Sterk].

1

Open het  
menuscherf

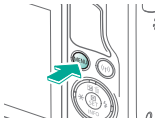

2

Stel de camera in



- [camera icon] → [Hoge ISO-ruisreductie] → [NR] → knop [SET]



# Ruis onderdrukken bij lange sluitertijden



Onderdruk ruis van lange belichting bij sluitertijden van één seconde of langzamer.

1

Open het  
menuscher  
m

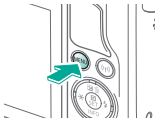

2

Stel de camera in



- [camera icon] → [Ruisred. lange sluitertijd] → kies een optie → knop [SET]



# Opnamen maken

## Specifieke sluitertijden en diafragmawaarden



Op basis van een voorbeeld	Auto-modus	Specifieke scènes
Beeldeffecten (Creatieve filters)	<b>Handmatige modus</b>	Films opnemen in de filmmodus
Handige functies		



Specifieke sluitertijden  
(modus Tv)



Specifieke diafragmawaarden  
(modus Av)



Specifieke helderheid/belichting  
(modus M)



Opnamen met lange  
belichtingstijd maken (Bulb)



Films opnemen met specifieke  
sluitertijden en diafragmawaarden





# Specifieke sluitertijden (modus Tv)



Lang



Kort

Stel de gewenste sluitertijd in voordat u begint met het maken van opnamen. Op de camera wordt de diafragma waarde automatisch aangepast aan de ingestelde sluitertijd.

1

Stel de modus in



2

Stel de opname-  
modus in



• [Tv] → [OK]

3

Stel de camera in



• Draai aan de  
knop 





## Specifieke sluitertijden (modus Tv)



Lang



Kort

Stel de gewenste sluitertijd in voordat u begint met het maken van opnamen. Op de camera wordt de diafragma waarde automatisch aangepast aan de ingestelde sluitertijd.

---

# 4

Maak de opname





# Specifieke diafragmawaarden (modus Av)



Klein



Groot

Stel de gewenste diafragma waarde in voordat u begint met het maken van opnamen. Op de camera wordt de sluitertijd automatisch aangepast aan de ingestelde diafragma waarde.

1

Stel de modus in



2

Stel de opname-  
modus in



• [Av] → [OK]

3

Stel de camera in



• Draai aan de knop 





## Specifieke diafragmawaarden (modus Av)



Klein



Groot

Stel de gewenste diafragma waarde in voordat u begint met het maken van opnamen. Op de camera wordt de sluitertijd automatisch aangepast aan de ingestelde diafragma waarde.

## 4

Maak de opname





# Specifieke helderheid/belichting (modus M)



Stel de sluitertijd en diafragma waarde in om uw gewenste belichting te verkrijgen.

1

Stel de modus in



2

Stel de opname-  
modus in



• **[M]** → [OK]

3

Stel de ISO-  
snelheid in.



• **[ISO AUTO]** →  
kies een ISO-snelheid





## Specifieke helderheid/belichting (modus M)



Stel de sluitertijd en diafragma waarde in om uw gewenste belichting te verkrijgen.

### 4

Stel de sluitertijd in



- Draai aan de knop 

### 5

Stel de diafragma waarde in



- Knop    
knop 

### 6

Maak de opname

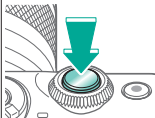



# Opnamen met lange belichtingstijd maken (Bulb)



Met bulbelichting worden opnamen belicht zolang u de ontspanknop helemaal ingedrukt houdt.

1

Stel de modus in



2

Stel de opname-modus in

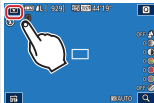

● **M** → [OK]

3

Stel de camera in





## Opnamen met lange belichtingstijd maken (Bulb)



Met bulbelichting worden opnamen belicht zolang u de ontspanknop helemaal ingedrukt houdt.

### 4

Maak de opname

- Draai de knop  om de sluitertijd in te stellen op [BULB].







# Films opnemen met specifieke sluitertijden en diafragmawaarden



Handmatige film

Stel de gewenste sluitertijd, diafragmawaarde en ISO-snelheid in.

1

Stel de modus in



2

Stel de opname-modus in



●  → [OK]

3

Stel de ISO-snelheid in.



● Knop  →  
knop 





# Films opnemen met specifieke sluitertijden en diafragmawaarden



Handmatige film

Stel de gewenste sluitertijd, diafragmawaarde en ISO-snelheid in.

4

Stel de sluitertijd in



5

Stel de diafragma-  
waarde in



6

Maak de opname





# Opnamen maken

## De camera aanpassen



Op basis van een voorbeeld	Auto-modus	Specifieke scènes
Beeldeffecten (Creatieve filters)	Handmatige modus	Films opnemen in de filmmodus
Handige functies		

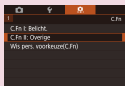

Persoonlijke voorkeuzes  
configureren



Items wijzigen op het scherm  
Snel instellen



Volgorde wijzigen van items  
op het scherm Snel instellen



# Persoonlijke voorkeuzes configureren



Configureer persoonlijke voorkeuzes op het tabblad [1] van het menu om de werking van de camera aan te passen aan uw opnamevoorkeuzen.

U kunt ook veelgebruikte functies toewijzen aan specifieke knoppen.

1

Open het  
menuscherm

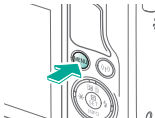

2

Selecteer het type  
functie dat u wilt  
aanpassen

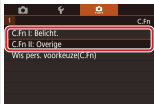

- [1] → kies een item → knop

3

Selecteer een  
functie



- Selecteer een functie → knop

4

Kies een optie

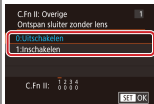

- Kies een optie → knop



# Items wijzigen op het scherm Snel instellen



# 1

Open het  
menuscherm

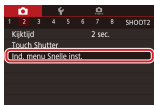

- [CAMERA] → [Ind. menu Snelle inst.] → knop

# 2

Kies pictogrammen  
die u wilt gebruiken



- Selecteer een pictogram → gebruik de knop om (✓) te selecteren → knop **MENU**

# 3

Stel de camera in



- [OK] → knop



# Volgorde wijzigen van items op het scherm Snel instellen



## 1

Open het menuscherm

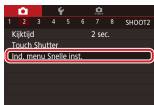
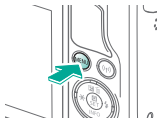

- [CAMERA] → [Ind. menu Snelle inst.] → knop

## 2

Wijzig de volgorde van de pictogrammen



- Tik op [Sorteer].



- Kies een pictogram → knop → knoppen ▲/▼ → kies een bestemming → knop → knop **MENU**





## 3

Stel de camera in



- [OK] → knop





# Opnamen maken

## Creatieve hulp



Op basis van een voorbeeld	Auto-modus	Specifieke scènes
Beeldeffecten (Creatieve filters)	<b>Handmatige modus</b>	Films opnemen in de filmmodus
Handige functies		



Opnamen maken met uw favoriete instellingen (Creatieve hulp)



Instellingen voor Creatieve hulp opslaan



Instellingen voor Creatieve hulp laden



Instellingen gebruiken van beelden uit Creatieve hulp





# Opnamen maken met uw favoriete instellingen (Creatieve hulp)



Vervaag de achtergrond, pas de helderheid aan of wijzig overige instellingen op andere manieren terwijl u naar het scherm kijkt. U kunt ook uw instellingen opslaan of instellingen toepassen van eerdere opnamen die u in de modus [★] hebt gemaakt.

1

Stel de modus in



2

Stel de opname-modus in

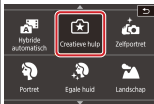

● [★] → [OK]

3

Open het instelscherm





## Opnamen maken met uw favoriete instellingen (Creatieve hulp)

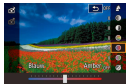

Vervaag de achtergrond, pas de helderheid aan of wijzig overige instellingen op andere manieren terwijl u naar het scherm kijkt. U kunt ook uw instellingen opslaan of instellingen toepassen van eerdere opnamen die u in de modus [📌] hebt gemaakt.

### 4

Stel de camera in



- Gebruik de knoppen ▲▼ om te bladeren → knoppen ◀▶ om aan te passen

### 5

Keer terug naar het opnamescherm

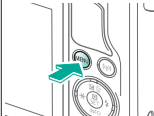

### 6

Maak de opname





# Instellingen voor Creatieve hulp opslaan



1

Stel de modus in



2

Stel de opname-  
modus in

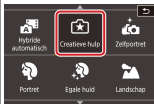

● [Creative hulp] → [OK]

3

Open het  
instelscherm





# Instellingen voor Creatieve hulp opslaan



## 4

Stel de camera in



- Gebruik de knoppen ▲/▼ om te bladeren → knoppen ◀▶ om aan te passen → knop

## 5

Registreer de instellingen



- → kies een optie → knop

## 6

Keer terug naar het opnamescherm



- [OK] → knop





# Instellingen voor Creatieve hulp laden



1

Stel de modus in



2

Stel de opname-modus in

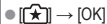

3

Open het instelscherm





## Instellingen voor Creatieve hulp laden



# 4

Laad de instellingen



- [of] → kies een optie → knop [SET]





# Instellingen gebruiken van beelden uit Creatieve hulp



1

Stel de modus in



2

Stel de opname-  
modus in

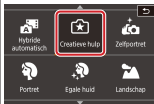

● [Creative hulp] → [OK]

3

Open de  
afspeelmodus





## Instellingen gebruiken van beelden uit Creatieve hulp



# 4

Selecteer een beeld  
uit de modus 





- Selecteer een beeld  
→ knop 

# 5

Pas de instellingen  
toe



-  → knop 







# Opnamen maken



Op basis van een voorbeeld	Auto-modus	Specifieke scènes
Beeldeffecten (Creatieve filters)	Handmatige modus	Films opnemen in de filmmodus
Handige functies		



Films opnemen



Time-lapsefilms opnemen  
(Time-lapse-movie)



De beeldhelderheid  
vergendelen of wijzigen



Het opnamevolume aanpassen



Automatische langzame  
sluiter uitschakelen



Het windfilter uitschakelen





## Opnamen maken



Op basis van een voorbeeld	Auto-modus	Specifieke scènes
Beeldeffecten (Creatieve filters)	Handmatige modus	Films opnemen in de filmmodus
Handige functies		



De demper gebruiken





# Films opnemen



Neem films op in de modus [📹] met diverse effecten en functies.

1

Stel de modus in



2

Stel de opname-modus in

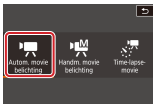

● [📹] → [OK]

3

Begin met opnemen





Neem films op in de modus [📹] met diverse effecten en functies.

---

## 4

Stop met opnemen

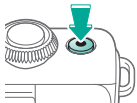



# De beeldhelderheid vergrendelen of wijzigen



Stel in richting -



Stel in richting +

Voor of tijdens een opname kunt u de belichting vergrendelen of wijzigen met stappen van 1/3 stop in een bereik van -3 tot +3 stops.

1

Stel de modus in



2

Stel de opname-  
modus in

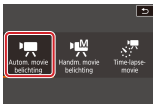

● [Movie] → [OK]

3

Vergrendel  
de belichting





Stel in richting -



Stel in richting +

Voor of tijdens een opname kunt u de belichting vergrendelen of wijzigen met stappen van 1/3 stop in een bereik van -3 tot +3 stops.

## 4

Pas de belichting aan



- Knop ▲ → draai de knop  terwijl u naar het scherm kijkt

## 5

Maak de opname

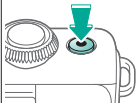





De automatische langzame sluiters kan worden uitgeschakeld indien er ruw bewogen wordt in films. Bij weinig licht kunnen films er echter donker uitzien.

## 4

Stel de camera in

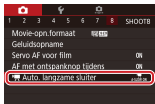

- [Camera] → [Auto, langzame sluiters] → knop [SET]



- [Uitsch.] → knop [SET]





# Time-lapsefilms opnemen (Time-lapse-movie)



Time-lapsefilms kunnen beelden combineren die automatisch worden vastgelegd met een ingesteld interval. Eventuele geleidelijke wijzigingen van het onderwerp (zoals de wijzigingen in een landschap) worden versneld afgespeeld.

1

Stel de modus in



2

Stel de opname-  
modus in

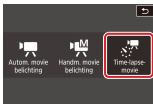

● [Time-lapse-movie icon] → [OK]

3

Stel de camera in





## Time-lapsefilms opnemen (Time-lapse-movie)



Time-lapsefilms kunnen beelden combineren die automatisch worden vastgelegd met een ingesteld interval. Eventuele geleidelijke wijzigingen van het onderwerp (zoals de wijzigingen in een landschap) worden versneld afgespeeld.

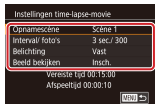

- Selecteer een item  
→ pas aan →  
knop **MENU**

# 4

Zet de camera vast en  
begin met opnemen





# Het opnamevolume aanpassen



Het opnamevolume  
aanpassen

Hoewel het opnameniveau (volume) automatisch wordt aangepast als [Automatisch] is ingesteld, kunt u het geluidsniveau ook handmatig instellen om bij de vastgelegde scène te passen.

1

Stel de modus in



2

Stel de opname-  
modus in

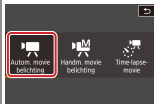

● [Movie] → [OK]

3

Open het  
menuscherm

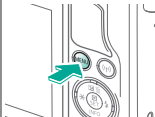



## Het opnamevolume aanpassen



Het opnamevolume  
aanpassen

Hoewel het opnameniveau (volume) automatisch wordt aangepast als [Automatisch] is ingesteld, kunt u het geluidsniveau ook handmatig instellen om bij de vastgelegde scène te passen.

### 4

Stel de camera in

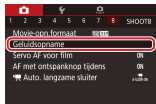

• [Camera] →  
[Geluidsoptname] →  
knop [SET]



• [Geluidsoptname] →  
[Handmatig] →  
knop [SET]





## Het opnamevolume aanpassen



Het opnamevolume  
aanpassen

Hoewel het opnameniveau (volume) automatisch wordt aangepast als [Automatisch] is ingesteld, kunt u het geluidsniveau ook handmatig instellen om bij de vastgelegde scène te passen.



- [Opname niveau] →  
knop → knoppen  
 om aan te passen  
→ knop



# Het windfilter uitschakelen



Geluid veroorzaakt door harde wind kan worden verminderd met het windfilter. Als er geen wind is, kan het opgenomen geluid bij gebruik van deze optie echter onnatuurlijk gaan klinken. In dit geval kunt u het windfilter uitschakelen.

1

Stel de modus in



2

Stel de opname-modus in

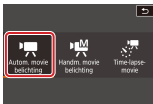

● [Wind] → [OK]

3

Open het menuscherm

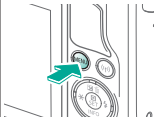



## Het windfilter uitschakelen



Geluid veroorzaakt door harde wind kan worden verminderd met het windfilter. Als er geen wind is, kan het opgenomen geluid bij gebruik van deze optie echter onnatuurlijk gaan klinken. In dit geval kunt u het windfilter uitschakelen.

### 4

Stel de camera in



- [Camera icon] → [Geluidsopname] → [Windfilter/demper] → knop [SET]

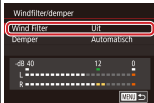

- [Wind Filter] → [Uit] → knop [SET]



# De demper gebruiken



Films opnemen op  
rumoerige plaatsen

Stel deze optie in op [Automatisch] om geluidsvervorming te verminderen door automatisch de demper in en uit te schakelen afhankelijk van de opnameomstandigheden. De demper kan ook handmatig op [Aan] of [Uit] worden ingesteld.

## 1

Stel de modus in



## 2

Stel de opname-  
modus in

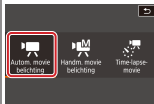

● [ ] → [OK]

## 3

Open het  
menuscherm

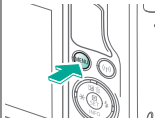





## De demper gebruiken



Films opnemen op  
rumoerige plaatsen

Stel deze optie in op [Automatisch] om geluidsvervorming te verminderen door automatisch de demper in en uit te schakelen afhankelijk van de opnameomstandigheden. De demper kan ook handmatig op [Aan] of [Uit] worden ingesteld.

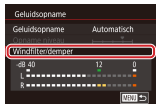

- [Camera icon] 8] →  
[Geluidsoptname] →  
[Windfilter/demper]  
→ knop [SET]

## 4

Stel de camera in

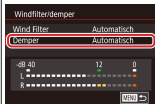

- [Demper] → kies een optie → knop [SET]



## Opnamen maken



Op basis van een voorbeeld	Auto-modus	Specifieke scènes
Beeldeffecten (Creatieve filters)	Handmatige modus	Films opnemen in de filmmodus
Handige functies		



De zelfontspanner gebruiken



Camerabeweging vermijden met de zelfontspanner



De zelfontspanner aanpassen



Opnamen maken door het scherm aan te raken (Touch Shutter)



Continue opname



Beeldkwaliteit wijzigen





## Opnamen maken



Op basis van een voorbeeld	Auto-modus	Specifieke scènes
Beeldeffecten (Creatieve filters)	Handmatige modus	Films opnemen in de filmmodus
Handige functies		



Vastleggen in RAW-indeling



De beeldverhouding wijzigen



Beeldkwaliteit van films wijzigen





# De zelfontspanner gebruiken



Met de zelfontspanner kunt u een groepsfoto maken waar u zelf ook op staat. De camera maakt de foto ongeveer 10 seconden nadat u de ontspanknop indrukt.

1

Open het instelscherm



2

Stel de camera in



● [OFF] → [C/D] →  
knop

3

Maak de opname





# Camerabeweging vermijden met de zelfontspanner



Met deze optie reageert de sluitersneling nadat u de ontspanknop indrukt met een vertraging van ongeveer twee seconden. Mocht de camera bewegen terwijl u de ontspanknop indrukt, dan heeft dat geen invloed op uw opname.

1

Open het instelscherm



2

Stel de camera in



● [OFF] → [C2] →  
knop

3

Maak de opname





# De zelfontspanner aanpassen



U kunt een vertraging (0–30 seconden) en het aantal opnamen (1–10) opgeven.

1

Open het instelscherm



2

Stel de camera in



● [OFF] → [C] →  
knop **MENU**



- Kies de tijd/aantal foto's → kies een waarde met knoppen ◀▶ → knop **MENU**





U kunt een vertraging (0–30 seconden) en het aantal opnamen (1–10) opgeven.

---

## 3

Maak de opname





# Opnamen maken door het scherm aan te raken (Touch Shutter)



Met deze optie kunt u gewoon het scherm aanraken en uw vinger wegnemen om de opname te maken, in plaats van de ontspanknop in te drukken.

De camera stelt automatisch scherp op onderwerpen en past automatisch de beeldhelderheid aan.

## 1

Stel de camera in



- Tik op  en verander de instelling in .

## 2

Maak de opname







# Continue opname



Houd in de modus [A+] de ontspalknop volledig ingedrukt om continue opnamen te maken.

1

Stel de modus in



2

Open het instelscherm



3

Stel de camera in



4

Maak de opname





## Continue opname



Houd in de modus [A+] de ontspanknop volledig ingedrukt om continue opnamen te maken.



- Houd de ontspanknop helemaal ingedrukt.



# Beeldkwaliteit wijzigen



	24,0 megapixel/ hoge kwaliteit		Circa 10,6 megapixel/ hoge kwaliteit		S1	Circa 5,9 megapixel/ hoge kwaliteit		S2	Circa 3,8 megapixel/ normale kwaliteit
	24,0 megapixel/ normale kwaliteit		Circa 10,6 megapixel/ normale kwaliteit		S1	Circa 5,9 megapixel/ normale kwaliteit			

1

Open het  
instelscherm



2

Kies het item dat  
u wilt instellen



- → kies een  
optie → knop



# Vastleggen in RAW-indeling



De camera kan beelden vastleggen in JPEG- en RAW-indeling. RAW-beelden bestaan uit onbewerkte gegevens die zijn opgenomen met zo goed als geen verlies aan beeldkwaliteit door beeldverwerking van de camera.

1

Open het instelscherm



2

Kies het item dat u wilt instellen



- Selecteer [L].

3

Stel de camera in



- Alleen RAW-indeling: kies [RAW]





## Vastleggen in RAW-indeling



De camera kan beelden vastleggen in JPEG- en RAW-indeling. RAW-beelden bestaan uit onbewerkte gegevens die zijn opgenomen met zo goed als geen verlies aan beeldkwaliteit door beeldverwerking van de camera.



- JPEG+RAW: kies de JPEG-beeldkwaliteit  
→ druk op de knop **MENU** en selecteer (✓) [RAW]



# De beeldverhouding wijzigen



16:9



3:2



4:3



1:1

1

Open het  
instelscherm



2

Kies het item dat  
u wilt instellen



- **3:2** → kies een optie → knop



# Beeldkwaliteit van films wijzigen



Pas de beeldkwaliteit van films aan (beeldformaat en framerate). De framerate geeft aan hoeveel frames worden opgenomen per seconde. Uw opties hangen af van de NTSC- of PAL-instelling.

1

Open het instelscherm



2

Kies het item dat u wilt instellen



- [FHD 29.97P] → kies een optie → knop [SET]



# Afspelen



Bekijken	Zoeken	Beheren
Beelden wissen	Foto's bewerken	RAW-beelden verwerken met de camera
Films bewerken		



Foto's bekijken



Beelden vergroten



Diavoorstellingen bekijken



Films bekijken



Digest-films bekijken





# Foto's bekijken

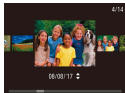

Nadat u beelden hebt vastgelegd, kunt u ze op het scherm bekijken.

1

Open de afspeelmodus



2

Blader door uw beelden



- Knop ►: volgend beeld
- Knop ◀: vorig beeld



# Beelden vergroten



Beelden kunnen worden vergroot of verkleind.

1

Open de  
afspeelmodus



2

Blader door  
uw beelden



3

Vergroot of  
verklein beelden

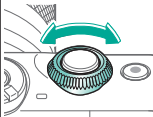

4

Wijzig de  
beeldweergave





## Beelden vergroten



Beelden kunnen worden vergroot of verkleind.



- Beelden verplaatsen:  
knoppen ▲/▼/◀▶
- Van beeld wisselen:  
knop  →  
knoppen ◀▶



# Diavoorstellingen bekijken



Speel automatisch beelden af vanaf een geheugenkaart.

1

Open de  
afspeelmodus



2

Open het  
menuscherf

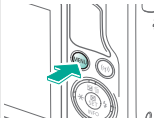

- [▶] →  
[Diavoorstelling] →  
knop [SET]

3

Speel de  
diavoorstelling af

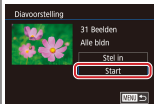

- [Start] → knop [SET]



# Films bekijken



Nadat u films hebt opgenomen, kunt u ze op het scherm bekijken.

Films zijn herkenbaar aan het pictogram **[SET ▶]**.

1

Open de afspelmodus



2

Blader door uw beelden



- Knop ▶: volgend beeld
- Knop ◀: vorig beeld





## Films bekijken



Nadat u films hebt opgenomen, kunt u ze op het scherm bekijken.

Films zijn herkenbaar aan het pictogram [SET ▶].

### 3

Speel de film af



● [▶] → knop

### 4

Pas het volume aan





# Digest-films bekijken



Er wordt automatisch een korte film gemaakt van scènes, inclusief uw foto's in de modus [A]. Door een digest-film af te spelen, worden de scènes getoond die op die dag zijn vastgelegd.

1

Open de afspeelmodus



2

Blader door uw beelden



3

Speel de film af





## Digest-films bekijken



Er wordt automatisch een korte film gemaakt van scènes, inclusief uw foto's in de modus [A]. Door een digest-film af te spelen, worden de scènes getoond die op die dag zijn vastgelegd.

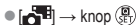





# Afspelen



Bekijken	Zoeken	Beheren
Beelden wissen	Foto's bewerken	RAW-beelden verwerken met de camera
Films bewerken		



Beelden in een index zoeken



Beelden zoeken die voldoen aan opgegeven voorwaarden



Beelden zoeken met de knop aan de voorkant



# Beelden in een index zoeken



U kunt snel de beelden vinden die u zoekt door meerdere beelden in een index weer te geven.

1

Open de  
afspeelmodus



2

Geef beelden  
weer in een index

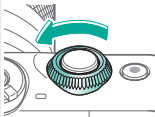

3

Blader door  
uw beelden

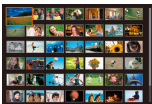



# Beelden zoeken die voldoen aan opgegeven voorwaarden



Vind snel de gewenste beelden op een geheugenkaart vol beelden door de beeldweergave te filteren op de door u opgegeven voorwaarden.

1

Open de afspelmodus



2

Open het instelscherm



3

Selecteer een voorwaarde



● [🔍] → knop [SET]





## Beelden zoeken die voldoen aan opgegeven voorwaarden



Vind snel de gewenste beelden op een geheugenkaart vol beelden door de beeldweergave te filteren op de door u opgegeven voorwaarden.



- Selecteer een voorwaarde.
- Nadat u [★/☑/📢] hebt gekozen: selecteer een tweede voorwaarde.

## 4

### Bekijk de beelden



- Beelden die voldoen aan de voorwaarden, worden in gele kaders weergegeven.



# Beelden zoeken met de knop aan de voorkant



Gebruik de knop aan de voorkant om beelden te vinden die aan uw voorwaarden voldoen en deze snel door te bladeren.

1

Open de  
afspeelmodus



2

Selecteer een  
voorwaarde



- Bij de weergave van afzonderlijke opnamen sleept u naar links of rechts met twee vingers.





## Beelden zoeken met de knop aan de voorkant



Gebruik de knop aan de voorkant om beelden te vinden die aan uw voorwaarden voldoen en deze snel door te bladeren.



- Wanneer zoekvoorwaarden worden weergegeven, drukt u op de knoppen ▲/▼ om een voorwaarde te selecteren.

### 3

Bekijk de beelden

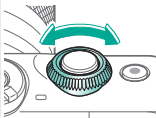



# Afspelen



Bekijken	Zoeken	Beheren
Beelden wissen	Foto's bewerken	RAW-beelden verwerken met de camera
Films bewerken		



Afzonderlijke beelden beveiligen

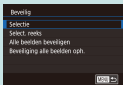

Meerdere beelden beveiligen

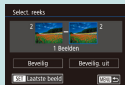

Een reeks beelden beveiligen

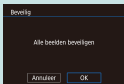

Alle beelden in één keer beveiligen



Beelden beoordelen (Classificatie)



# Afzonderlijke beelden beveiligen



Afzonderlijke beelden kunnen worden beveiligd om te voorkomen dat belangrijke beelden per ongeluk worden gewist.

1

Open de afspelmodus



2

Blader door uw beelden



3

Open het instelscherm



4

Beveilig



● [Beveilig] → [Beveilig] →  
knop





# Meerdere beelden beveiligen



Er kunnen meerdere beelden afzonderlijk worden geselecteerd en beveiligd.

1

Open de afspelmodus



2

Open het menuscherm

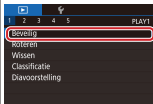
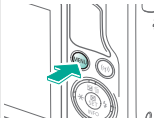

- [▶] 1 → [Beveilig]  
→ knop

3

Kies het item dat u wilt instellen



- [Selectie] → knop





## Meerdere beelden beveiligen



Er kunnen meerdere beelden afzonderlijk worden geselecteerd en beveiligd.

### 4

Blader door uw beelden



- Selecteer een beeld  
→ knop

### 5

Beveilig

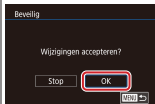
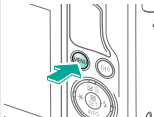

- [OK] → knop



# Een reeks beelden beveiligen



Reeksen van beelden kunnen worden beveiligd om te voorkomen dat belangrijke beelden per ongeluk worden gewist.

1

Open de afspelmmodus



2

Open het menuscherm

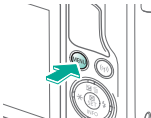

3

Kies het item dat u wilt instellen



- [▶]1 → [Beveilig] → [Select. reeks] → knop





## Een reeks beelden beveiligen

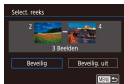

Reeksen van beelden kunnen worden beveiligd om te voorkomen dat belangrijke beelden per ongeluk worden gewist.

# 4

Selecteer het eerste beeld

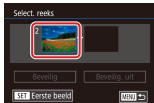

- [Eerste beeld]  
→ knop



- Selecteer een beeld  
→ knop

# 5

Selecteer het laatste beeld

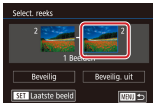

- [Laatste beeld]  
→ knop



- Selecteer een beeld  
→ knop

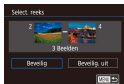

Reeksen van beelden kunnen worden beveiligd om te voorkomen dat belangrijke beelden per ongeluk worden gewist.

## 6

### Beveilig



- Knop ▼ → [Beveilig]  
→ knop SET



# Alle beelden in één keer beveiligen

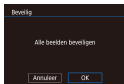

Alle beelden kunnen worden beveiligd om te voorkomen dat belangrijke beelden per ongeluk worden gewist.

1

Open de afspelmmodus



2

Open het menuscherm

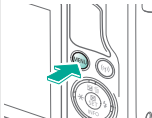

3

Kies het item dat u wilt instellen



- [▶] 1 → [Beveilig] → [Alle beelden beveiligen] → knop [SET]





## Alle beelden in één keer beveiligen

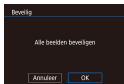

Alle beelden kunnen worden beveiligd om te voorkomen dat belangrijke beelden per ongeluk worden gewist.

# 4

Stel de camera in



● [OK] → knop 



# Beelden beoordelen (Classificatie)



Orden beelden door ze een classificatie te geven op een schaal van 1–6.

1

Open de  
afspeelmodus



2

Blader door  
uw beelden



3

Open het  
instelscherm



4

Stel de camera in



- [★] → kies een classificatie →  
knop





# Afspelen



Bekijken	Zoeken	Beheren
Beelden wissen	Foto's bewerken	RAW-beelden verwerken met de camera
Films bewerken		



Afzonderlijke beelden wissen



Meerdere beelden wissen

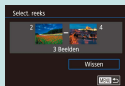

Een reeks beelden wissen

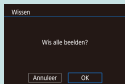

Alle beelden wissen



# Afzonderlijke beelden wissen



U kunt beelden die u niet meer nodig hebt één voor één selecteren en wissen. Wees voorzichtig bij het wissen van beelden, want ze kunnen niet worden hersteld.

1

Open de afspelmodus



2

Blader door uw beelden



3

Wissen



● [Wissen] → knop



# Meerdere beelden wissen



Er kunnen meerdere beelden afzonderlijk worden geselecteerd en gewist. Wees voorzichtig bij het wissen van beelden, want ze kunnen niet worden hersteld.

1

Open de afspelmmodus



2

Open het menuscherm

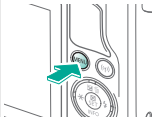

3

Kies het item dat u wilt instellen



- [▶] 1 → [Wissen] → [Selectie] → knop [SET]

4

Blader door uw beelden







Er kunnen meerdere beelden afzonderlijk worden geselecteerd en gewist. Wees voorzichtig bij het wissen van beelden, want ze kunnen niet worden hersteld.

### 5

#### Wissen

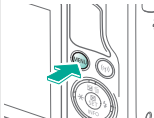
- Selecteer een beeld → gebruik de knop  om  te selecteren



- [OK] → knop 



# Een reeks beelden wissen



Het is mogelijk een reeks beelden te selecteren en te wissen. Wees voorzichtig bij het wissen van beelden, want ze kunnen niet worden hersteld.

1

Open de afspelmodus



2

Open het menuscherm

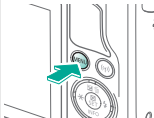

3

Kies het item dat u wilt instellen



- [▶] 1 → [Wissen] → [Select. reeks] → knop





## Een reeks beelden wissen



Het is mogelijk een reeks beelden te selecteren en te wissen. Wees voorzichtig bij het wissen van beelden, want ze kunnen niet worden hersteld.

# 4

Selecteer het eerste beeld



- [Eerste beeld]  
→ knop



- Selecteer een beeld  
→ knop

# 5

Selecteer het laatste beeld



- [Laatste beeld]  
→ knop



- Selecteer een beeld  
→ knop



Het is mogelijk een reeks beelden te selecteren en te wissen.  
Wees voorzichtig bij het wissen van beelden, want ze kunnen niet worden hersteld.

## 6

### Wis



- Knop ▼ → [Wissen]
- knop



# Alle beelden wissen

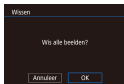

Alle beelden kunnen tegelijk worden gewist. Wees voorzichtig bij het wissen van beelden, want ze kunnen niet worden hersteld.

1

Open de afspelmodus



2

Open het menuscherm

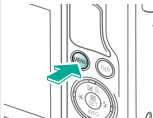

3

Kies het item dat u wilt instellen



- [▶] 1 → [Wissen]  
→ [Sel. alle beelden]  
→ knop [SET]





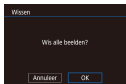

Alle beelden kunnen tegelijk worden gewist. Wees voorzichtig bij het wissen van beelden, want ze kunnen niet worden hersteld.

## 4

### Wis



● [OK] → knop 



# Afspelen



Bekijken	Zoeken	Beheren
Beelden wissen	Foto's bewerken	RAW-beelden verwerken met de camera
Films bewerken		



Beelden draaien



Het formaat van beelden wijzigen



Trimmen



Filtereffecten toepassen



Rode-ogen corrigeren



# Beelden draaien



Wijzig de horizontale of verticale stand van beelden en sla ze op.

1

Open de  
afspeelmodus



2

Blader door  
uw beelden



3

Open het  
instelscherm



4

Kies het item dat  
u wilt instellen



● Selecteer [Q].





## Beelden draaien



Wijzig de horizontale of verticale stand van beelden en sla ze op.

# 5

Draai het beeld

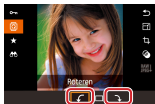

• [↶/↷] → knop



# Het formaat van beelden wijzigen



Sla een kleinere versie van een beeld op, met minder pixels.

1

Open de  
afspeelmodus



2

Blader door  
uw beelden



3

Open het  
instelscherm



4

Kies het item dat  
u wilt instellen

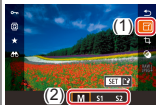

- → kies een optie
- knop





Sla een kleinere versie van een beeld op, met minder pixels.

## 5

Sla het nieuwe beeld op



● [OK] → knop

## 6

Bekijk het nieuwe beeld



● [Bewerkt beeld] → knop



# Trimmen



U kunt een gedeelte van een beeld opgeven om als afzonderlijk beeldbestand op te slaan.

1

Open de afspeelmodus



2

Blader door uw beelden



3

Open het instelscherm



4

Kies het item dat u wilt instellen



● [Crop Icon] → knop [SET]





U kunt een gedeelte van een beeld opgeven om als afzonderlijk beeldbestand op te slaan.

## 5

Pas het  
bijsnijdkader aan



- Afmetingen veranderen: knijp uw vingers samen of spreid uw vingers op het scherm
- Verplaatsen: knoppen ▲/▼/◀▶

## 6

Bekijk een  
voorbeeld



- Horizontale of verticale stand wijzigen: knop → → knop
- Beeldverhouding wijzigen: knop → → knop





# Trimmen



U kunt een gedeelte van een beeld opgeven om als afzonderlijk beeldbestand op te slaan.

## 7

Sla het nieuwe beeld op



- Knop  →  → knop 



- [OK] → knop 

## 8

Bekijk het nieuwe beeld



- [Bewerkt beeld] → knop 

- Knop  →  → knop 
- Van weergave wisselen:  Knop





# Filtereffecten toepassen



Pas effecten toe die gelijk zijn aan opnamen maken in de standen [📷/👤/📱/🔍/🖱️/📷/📷] en sla deze bewerkte opnamen op als afzonderlijke beelden.

1

Open de afspeelmodus



2

Blader door uw beelden



3

Open het instelscherm



4

Kies een effect



- [📷] → kies een optie → knop [SET]



## Filtereffecten toepassen



Pas effecten toe die gelijk zijn aan opnamen maken in de standen [📷 👤 📱 🖱️ 🖱️ 📷 📷] en sla deze bewerkte opnamen op als afzonderlijke beelden.

# 5

Pas het effect aan

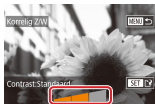

- Gebruik de knoppen ▲/▼/◀/▶ of de knop  om aan te passen → knop 

# 6

Sla het nieuwe beeld op

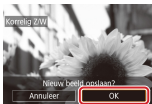

- [OK] → knop 

# 7

Bekijk het nieuwe beeld



- [Bewerkt beeld] → knop 



# Rode-ogen corrigeren



Hiermee corrigeert u automatisch beelden met rode ogen. U kunt het gecorrigeerde beeld opslaan als een afzonderlijk bestand.

1

Open de afspeelmodus



2

Open het menuscherm

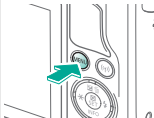

3

Kies het item dat u wilt instellen

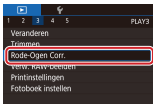

• [▶] 3] →  
[Rode-Ogen Corr.] →  
knop [SET]





## Rode-ogen corrigeren



Hiermee corrigeert u automatisch beelden met rode ogen. U kunt het gecorrigeerde beeld opslaan als een afzonderlijk bestand.

4

Blader door uw beelden



5

Corrigeer het beeld



• Druk op de knop

6

Sla het nieuwe beeld op

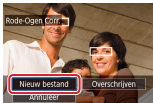

• [Nieuw bestand] → knop

7

Bekijk het nieuwe beeld





## Rode-ogen corrigeren



Hiermee corrigeert u automatisch beelden met rode ogen. U kunt het gecorrigeerde beeld opslaan als een afzonderlijk bestand.



- Knop **MENU** →  
[Bewerkt beeld] →  
knop



# Afspelen



Bekijken	Zoeken	Beheren
Beelden wissen	Foto's bewerken	RAW-beelden verwerken met de camera
Films bewerken		



RAW-beelden verwerken



Verwerkingsvoorwaarden instellen en RAW-beelden verwerken



# RAW-beelden verwerken



Verwerk op de camera beelden die zijn vastgelegd in RAW-indeling. Het oorspronkelijke RAW-beeld wordt bewaard en een kopie wordt opgeslagen als JPEG.

1

Open de afspeelmodus



2

Selecteer een RAW-beeld



3

Open het instelscherm



4

Kies het item dat u wilt instellen



● [RAW] [JPEG] → [RAW] [JPEG] →  
knop [SET]







Verwerk op de camera beelden die zijn vastgelegd in RAW-indeling. Het oorspronkelijke RAW-beeld wordt bewaard en een kopie wordt opgeslagen als JPEG.

## 5

Sla op



● [OK] → knop

## 6

Bekijk het nieuwe beeld



● [Bewerkt beeld] → knop



# Verwerkingsvoorwaarden instellen en RAW-beelden verwerken



Er kunnen uitgebreide verwerkingsvoorwaarden worden ingesteld voordat RAW-beelden op de camera worden verwerkt. Het oorspronkelijke RAW-beeld wordt bewaard en een kopie wordt opgeslagen als JPEG.

1

Open de  
afspeelmodus



2

Selecteer een  
RAW-beeld



3

Open het  
instelscherm



4

Kies het item dat  
u wilt instellen



● [RAW | JPEG] → [RAW | JPEG] →  
knop [SET]





## Verwerkingsvoorwaarden instellen en RAW-beelden verwerken



Er kunnen uitgebreide verwerkingsvoorwaarden worden ingesteld voordat RAW-beelden op de camera worden verwerkt. Het oorspronkelijke RAW-beeld wordt bewaard en een kopie wordt opgeslagen als JPEG.

### 5

Stel de verwerkingsvoorwaarden in



- Selecteer een item → knop



- Kies een optie → knop

### 6

Sla op



- → knop → [OK] → knop

### 7

Bekijk het nieuwe beeld



- [Bewerkt beeld] → knop



# Afspelen



Bekijken	Zoeken	Beheren
Beelden wissen	Foto's bewerken	RAW-beelden verwerken met de camera
Films bewerken		

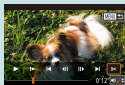

Het begin/einde van films  
wegknippen



Bestandsgroottes verkleinen



Digest-films bewerken



# Het begin/einde van films wegnippen



U kunt onnodige delen aan het begin en einde van films verwijderen. Houd er rekening mee dat digest-films niet kunnen worden bijgeknipt.

1

Open de afspeelmodus



2

Blader door uw films

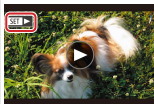

- Kies een film → knop

3

Start en onderbreek het afspelen



- → knop → knop tijdens afspelen





## Het begin/einde van films wegnippen



U kunt onnodige delen aan het begin en einde van films verwijderen. Houd er rekening mee dat digest-films niet kunnen worden bijgeknipt.

### 4

Kies het item dat u wilt instellen



- [SC] → knop [SET]

### 5

Geef aan welke delen u weg wilt knippen



- [V] → knoppen [L] om [R] te verplaatsen
- [SC] wordt weergegeven.
- Snijd het begin van de film af (vanaf [L]) door [V] te selecteren en snijd het einde van de film af met behulp van [R].



## Het begin/einde van films wegnippen



U kunt onnodige delen aan het begin en einde van films verwijderen. Houd er rekening mee dat digest-films niet kunnen worden bijgeknipt.

# 6

Bekijk de bewerkte film



● [▶] → knop

# 7

Sla op



● [] → knop



● [Nieuw bestand] → knop



● [Opsl. -compr.] → knop



# Bestandsgrroottes verkleinen



Het formaat van bestanden kan worden verkleind door films te comprimeren.

1

Open de afspeelmodus



2

Blader door uw films

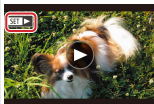

- Kies een film → knop

3

Start en onderbreek het afspelen



- → knop → knop tijdens afspelen







## Bestandsgroottes verkleinen



Het formaat van bestanden kan worden verkleind door films te comprimeren.

4

Kies het item dat u wilt instellen

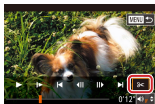

● [SE] → knop

5

Kies het item dat u wilt instellen



● [SE] → knop

6

Sla op



● [Nieuw bestand] → knop



● [Compr. & Opsl.] → knop



# Digest-films bewerken



Afzonderlijke hoofdstukken (clips) die zijn opgenomen in de modus [A], kunnen eventueel worden gewist. Wees voorzichtig bij het wissen van clips, want ze kunnen niet worden hersteld.

1

Open de afspeelmodus



2

Blader door uw beelden



- Selecteer een beeld met [SET] → knop [SET]





## Digest-films bewerken



Afzonderlijke hoofdstukken (clips) die zijn opgenomen in de modus [A], kunnen eventueel worden gewist. Wees voorzichtig bij het wissen van clips, want ze kunnen niet worden hersteld.

### 3

Start en onderbreek het afspelen



- [A] → knop [SET] → knop [SET] tijdens afspelen

### 4

Selecteer de clip die u wilt wissen



- [Previous/Next] → knop [SET]

### 5

Selecteer [Wissen]

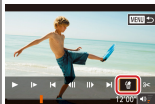

- [Wissen] → knop [SET]



Afzonderlijke hoofdstukken (clips) die zijn opgenomen in de modus [A], kunnen eventueel worden gewist. Wees voorzichtig bij het wissen van clips, want ze kunnen niet worden hersteld.

## 6

Wis

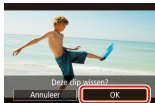

● [OK] → knop



# Draadloze functies



Beschikbare draadloze functies



Beelden verzenden naar een smartphone die NFC ondersteunt



Beelden verzenden naar een smartphone die NFC ondersteunt (afspeelmodus)



Beelden verzenden naar een smartphone met Bluetooth

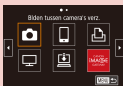

Webservices registreren  
CANON IMAGE GATEWAY



Webservices registreren  
Overige webservices



Beelden uploaden naar webservices



## Wi-Fi-functies

### Smartphones en tablets

Verzend beelden naar smartphones en tablets die beschikken over Wi-Fi-functies.

### Webservices

Verzend beelden naar CANON iMAGE GATEWAY of andere webservices.

## Bluetooth®-functies

U kunt de camera eenvoudig koppelen met een smartphone die beschikt over BLE-technologie (Bluetooth low energy, hierna simpelweg "Bluetooth" genoemd).

U kunt opnamen maken of bekijken door uw smartphone als afstandsbediening te gebruiken.





## Beschikbare draadloze functies



### Mediaspelers

Bekijk beelden op tv's of andere apparaten die DLNA\* ondersteunen.

\* Digital Living Network Alliance

### Printers

Print beelden draadloos met een printer die PictBridge ondersteunt (DPS over IP wordt ondersteund).

### Andere camera's

Verzend en ontvang beelden draadloos naar en van Canon-camera's die Wi-Fi ondersteunen.

Raadpleeg de hulpgids voor instructies over deze drie functies.





# Beelden verzenden naar een smartphone die NFC ondersteunt



1

Zet de camera aan



2

Installeer Camera Connect



- Zet NFC aan.

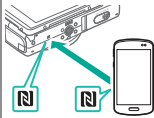

- Houd de **N**-markeringen tegen elkaar.
- Google Play wordt automatisch geopend op de smartphone.



- Download en installeer Camera Connect.







## Beelden verzenden naar een smartphone die NFC ondersteunt



### 3

Breng de verbinding tot stand

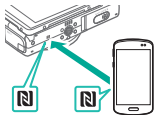

- Houd de **N**-markeringen tegen elkaar.



- [OK] → knop
- Camera Connect wordt gestart op de smartphone en de apparaten maken automatisch verbinding.

### 4

Pas de privacyinstelling aan



- [Alle beelden] → knop

### 5

Verzend



- Selecteer een beeld → [Dit beeld verz.] → knop





# 6

Beëindig de  
verbinding

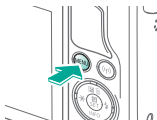

● Knop **MENU** →  
[OK] → knop





# Beelden verzenden naar een smartphone die NFC ondersteunt (afspeelmodus)



1

Open de afspeelmodus



2

Installeer Camera Connect



- Zet NFC aan.

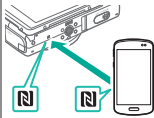

- Houd de **N**-markeringen tegen elkaar.
- Google Play wordt automatisch geopend op de smartphone.



- Download en installeer Camera Connect.





## Beelden verzenden naar een smartphone die NFC ondersteunt (afspeelmodus)



### 3

Breng de verbinding tot stand

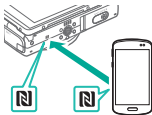

- Houd de **N**-markeringen tegen elkaar.



- [OK] → knop
- Camera Connect wordt gestart op de smartphone en de apparaten maken automatisch verbinding.

### 4

Blader door uw beelden



- Selecteer een beeld → gebruik de knop om (✓) te selecteren
- Knop **MENU** → [OK] → knop

### 5

Verzend



- [Verzenden] → knop





## Beelden verzenden naar een smartphone die NFC ondersteunt (afspeelmodus)



# 6

Beëindig de  
verbinding

- Knop **MENU** →  
[OK]





# Beelden verzenden naar een smartphone met Bluetooth



## 1

Installeer Camera Connect



- Download en installeer Camera Connect via de App Store/ Google Play.

## 2

Zet de camera aan



## 3

Registreer een bijnaam

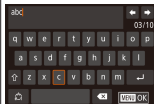

- Knop **MENU**  
→ [Y4] →  
[Inst. draadloze  
communicatie] →  
[Bijnaam] →  
knop

- Voer een bijnaam in  
→ knop **MENU**





# Beelden verzenden naar een smartphone met Bluetooth



- Het scherm [Inst. draadloze communicatie] wordt opnieuw weergegeven.

## 4

Bereid het koppelen voor



- [Bluetooth-instellingen] → [Pairing] → knop



- De camera is klaar om verbinding te maken.

## 5

Open Camera Connect



- Zet Bluetooth aan.
- Open Camera Connect.





## Beelden verzenden naar een smartphone met Bluetooth



# 6

Selecteer de camera waarmee u verbinding wilt maken



- Doe dit op de smartphone.



# 7

Voltooi het koppelen



- [OK] → knop



- Druk op de knop

# 8

Importeer beelden



- Doe dit op de smartphone.





# Webservices registreren

## CANON IMAGE GATEWAY



1

Open het  
Wi-Fi-menu



- Als het scherm [Bijnaam apparaat] wordt weergegeven: [OK] → knop

2

Selecteer []



- [] → knop

3

Ga akkoord met de  
overeenkomst om een  
e-mailadres in te voeren



- [Akkoord] → knop





# Webservices registreren CANON IMAGE GATEWAY



## 4

Kies hoe u verbinding wilt maken met het toegangspunt



### (a) WPS-verbinding

- [Verbind via WPS]  
→ knop  →  
step 5 (A)

### (b) Uit de lijst kiezen

- Kies een toegangspunt → knop  →  
step 5 (B)

## 5

(A) Breng de verbinding tot stand



- [WPS (PBC-modus)]  
→ knop 



- Houd op het toegangspunt de WPS-verbindingknop enkele seconden ingedrukt.





# Webservices registreren



## CANON IMAGE GATEWAY



- Druk op de knop .

### (B) Breng de verbinding tot stand



- Knop  → voer het wachtwoord in → [Volgende] → knop .





- [Auto] → knop .

## 6

### Voer uw e-mailadres in



- Knop  → voer uw e-mailadres in → [Volgende] → knop .





# Webservices registreren CANON IMAGE GATEWAY



## 7

Voer een viercijferig nummer in



- Knop → voer een nummer in → [Volgende] → knop
- Dit nummer is ook nodig bij stap 9.

## 8

Controleer of u het bericht hebt ontvangen



- U ontvangt een melding op het e-mailadres dat u bij stap 6 hebt ingevoerd.
- Druk in het bevestigingsscherm op de knop .

## 9

Stel de koppeling van de camera in

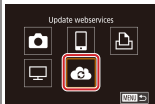

- [] verandert nu in [].



- Ga op een computer/smartphone naar de pagina uit het bericht en volg de instructies.





## Webservices registreren CANON iIMAGE GATEWAY



- [📶] → knop [SET]
- [📺] en CANON iIMAGE GATEWAY worden nu als bestemmingen toegevoegd.





# Webservices registreren

## Overige webservices



1

Open het instelscherm



- Ga op een computer/ smartphone naar <http://www.canon.com/cig/> om naar CANON iMAGE GATEWAY te gaan.

2

Stel de webservice in die u wilt gebruiken



- Volg de instructies om de instellingen te voltooien.

3

Open het Wi-Fi-menu

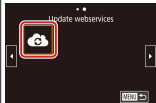

- [Cloud icon] → knop [SET]
- De instellingen voor de webservice zijn nu bijgewerkt.



## 1

Open het  
Wi-Fi-menu



## 2

Kies de  
bestemming



- Kies een pictogram  
→ knop
- Als het scherm  
[Ontvanger selecteren]  
wordt weergegeven:  
kies een optie →  
knop

## 3

Verzend



- Selecteer een beeld  
→ [Dit beeld verz.]  
→ knop
- [OK] op het scherm  
na verzending →  
knop



# Overige instellingen



Voorkomen dat het AF-hulplicht afgaat

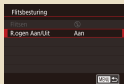

Het lampje voor rode-ogenreductie uitschakelen

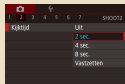

De weergaveduur van het beeld na opnamen wijzigen

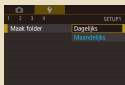

Beelden opslaan op datum

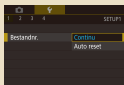

Bestandsnummering

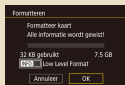

Geheugenkaarten formatteren

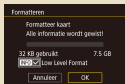

Een low-levelformattering uitvoeren

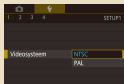

Het videosysteem wijzigen

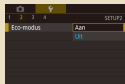

Eco-modus gebruiken







# Overige instellingen

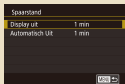

De slaarstand aanpassen



Schermhelderheid

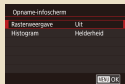

Het opname-informatiescherm aanpassen

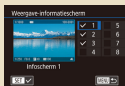

Het weergave-informatiescherm aanpassen

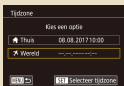

Wereldklok



Datum en tijd



Weergavetaal

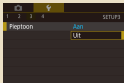

Camerageluiden dempen

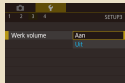

Camerageluiden activeren



# Overige instellingen

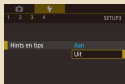

Hints en tips verbergen

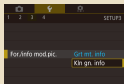

Opnamemodi als pictogram weergeven

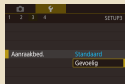

Het touchscreen aanpassen

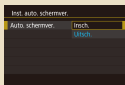

Het touchscreen automatisch vergrendelen



Automatische sensorreiniging uitschakelen

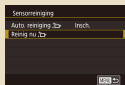

Sensorreiniging activeren



De sensor handmatig reinigen

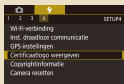

Certificatielogo's controleren

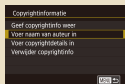

Auteursrechtinformatie instellen die in beelden moet worden vastgelegd



## Overige instellingen



Alle copyrightinformatie  
verwijderen

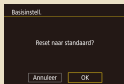

Standaardinstellingen van  
de camera herstellen



Standaardwaarden herstellen  
voor afzonderlijke camerafuncties





# Voorkomen dat het AF-hulplicht afgaat



Het lampje gaat branden als hulp bij het scherpstellen als u de ontspannoknup half indrukt in omstandigheden met weinig licht. Dit lampje kan worden uitgeschakeld.

1

Open het  
menuscherin

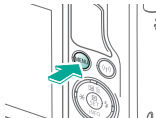

2

Kies het item dat  
u wilt instellen



3

Stel de camera in

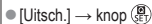
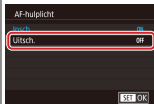



# Het lampje voor rode-ogenreductie uitschakelen



Wanneer u opnamen maakt met de flitser in een omgeving met weinig licht, gaat er een lampje branden dat het effect van rode ogen vermindert. Dit lampje kan worden uitgeschakeld.

1

Open het  
menuscherf

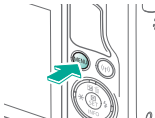

2

Kies het item dat  
u wilt instellen



● [CAMERA] →  
[Flitsbesturing] →  
knop [SET]

3

Stel de camera in

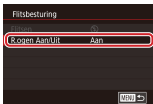

● [R.ogen Aan/Uit] →  
knop [SET]

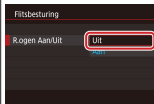

● [Uit] → knop [SET]



# De weergaveduur van het beeld na opnamen wijzigen



1

Open het  
menuscherm

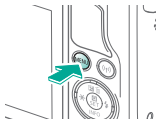

2

Kies het item dat  
u wilt instellen

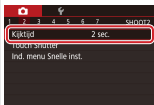

● [Kamera 2] → [Kijktijd] →  
knop

3

Stel de camera in

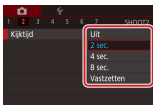

● Kies een optie →  
knop



# Beelden opslaan op datum



U kunt beelden opslaan in mappen die elke maand worden gemaakt, maar u kunt de camera ook mappen laten maken voor elke dag waarop u opnamen maakt.

1

Open het  
menuscherm

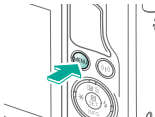

2

Kies het item dat  
u wilt instellen

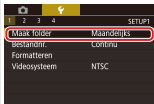

- [1] → [Maak folder]  
→ knop [SET]

3

Stel de camera in

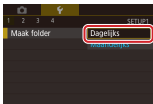

- [Dagelijks]  
→ knop [SET]



# Bestandsnummering



Uw opnamen worden automatisch opeenvolgend genummerd (0001–9999) en opgeslagen in mappen die elk maximaal 2000 opnamen kunnen bevatten. U kunt de toewijzing van de bestandsnummers wijzigen.

1

Open het  
menuscherm

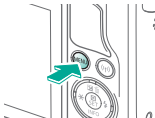

2

Kies het item dat  
u wilt instellen

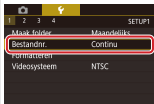

- → [Bestandnr.]  
→ knop

3

Stel de camera in

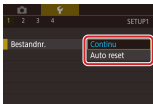

- Kies een optie  
→ knop





# Geheugenkaarten formatteren



Voordat u een nieuwe geheugenkaart of een geheugenkaart die is geformatteerd in een ander apparaat gaat gebruiken, moet u de kaart formatteren met deze camera. Door een geheugenkaart te formatteren, worden alle gegevens op de geheugenkaart gewist. De gegevens kunnen dan niet meer worden hersteld.

1

Open het  
menuschermb



2

Kies het item dat  
u wilt instellen

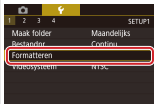

- [👉1] → [Formatteren]  
→ knop

3

Voer de bewerking  
uit



- [OK] → knop



- [OK] → knop →  
[OK]



# Een low-levelformatter uitvoeren



Voer een low-levelformatter uit in de volgende gevallen: [Geheugenkaart fout] wordt weergegeven, de camera functioneert niet goed, beelden op de kaart worden trager gelezen of opgeslagen, het maken van continue opnamen gaat langzamer of het opnemen van een film wordt plotseling afgebroken.

Een low-levelformatter wist alle gegevens op een geheugenkaart. De gegevens kunnen dan niet meer worden hersteld.

1

Open het  
menuschermb

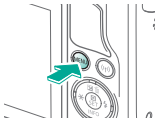

2

Kies het item dat  
u wilt instellen

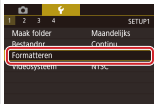

- 1 → [Formatteren]  
→ knop

3

Voer de bewerking  
uit



- Gebruik knop om  
() te selecteren →  
[OK] → knop





## Een low-levelformatting uitvoeren



Voer een low-levelformatting uit in de volgende gevallen: [Geheugenkaart fout] wordt weergegeven, de camera functioneert niet goed, beelden op de kaart worden trager gelezen of opgeslagen, het maken van continue opnamen gaat langzamer of het opnemen van een film wordt plotseling afgebroken.

Een low-levelformatting wist alle gegevens op een geheugenkaart. De gegevens kunnen dan niet meer worden hersteld.

---



● [OK] → knop  → [OK]



# Het videosysteem wijzigen



Stel het videosysteem in voor elke televisie die wordt gebruikt voor weergave. Deze instelling wijzigt ook de opties voor beeldkwaliteit (framerate) die beschikbaar zijn voor films.

1

Open het  
menuscherm

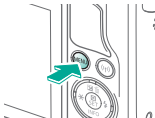

2

Kies het item dat  
u wilt instellen

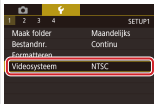

● [1] →  
[Videosysteem] →  
knop

3

Stel de camera in

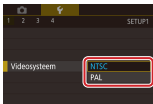

● Kies een optie →  
knop



# Eco-modus gebruiken



Met deze functie kunt u accustroom sparen in de opnamemodus. Wanneer de camera niet in gebruik is, wordt het scherm donker zodat de accu langer meegaat.

1

Open het  
menuscher  
m



2

Kies het item dat  
u wilt instellen

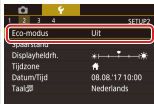

● [F2] → [Eco-modus]  
→ knop

3

Stel de camera in

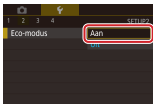

● [Aan] → knop



# De spaarstand aanpassen



U kunt desgewenst de timing voor het automatisch uitschakelen van de camera en het scherm (respectievelijk Automatisch Uit en Display uit) aanpassen.

1

Open het  
menuschermb

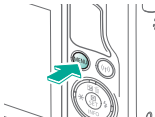

2

Kies het item dat  
u wilt instellen

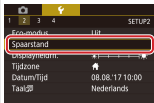

- [Y2] → [Spaarstand]  
→ knop

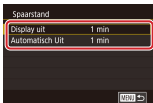

- [Display uit] of  
[Automatisch Uit] →  
knop





U kunt desgewenst de timing voor het automatisch uitschakelen van de camera en het scherm (respectievelijk Automatisch Uit en Display uit) aanpassen.

## 3

Stel de camera in



- Pas aan → knop



# Schermhelderheid



Pas de helderheid van het scherm aan.

1

Open het  
menuschermb



2

Kies het item dat  
u wilt instellen

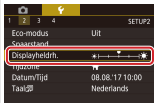

• [2] →  
[Displayheldrh.] →  
knop [SET]

3

Stel de camera in







## Schermhelderheid



Pas de helderheid van het scherm aan.

---



- Pas de helderheid aan met knoppen

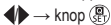



# Het opname-informatiescherm aanpassen



Er kan een raster worden weergegeven op het opnamescherm. U kunt ook het type histogram kiezen dat wordt weergegeven wanneer de knop ▼ wordt ingedrukt.

1

Open het  
menuscher

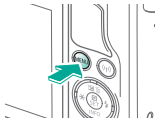

2

Kies het item dat  
u wilt instellen

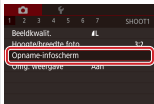

• [camera icon] → [Opname-  
infoscherm] →  
knop [SET]

3

Stel de camera in





## Het opname-informatiescherm aanpassen



Er kan een raster worden weergegeven op het opnamescherm. U kunt ook het type histogram kiezen dat wordt weergegeven wanneer de knop ▼ wordt ingedrukt.

### 4

#### Stel de camera in

- [Rasterweergave] of [Histogram] → knop

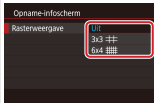

- Kies een optie met knoppen ▲/▼ → knop



# Het weergave-informatiescherm aanpassen



De weergegeven opname-informatie verandert telkens wanneer u in de afspeelmodus op de knop ▼ drukt. U kunt aanpassen welke informatie wordt weergegeven.

1

Open het  
menuscher

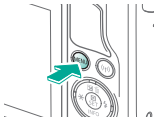

2

Kies het item dat  
u wilt instellen

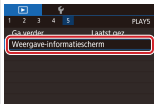

• [ [▶] 5 ] → [Weergave-  
informatiescherm] →  
knop [SET]

3

Stel de camera in





## Het weergave-informatiescherm aanpassen



De weergegeven opname-informatie verandert telkens wanneer u in de afspeelmodus op de knop ▼ drukt. U kunt aanpassen welke informatie wordt weergegeven.

---



- Selecteer informatie om weer te geven → gebruik de knop  om (✓) te selecteren



# Wereldklok



Als u in het buitenland bent en wilt dat uw foto's de juiste lokale tijd en datum krijgen, moet u gewoon uw bestemming van tevoren registreren en naar die tijdzone overschakelen. Deze handige functie maakt het onnodig om de datum/tijd-instelling handmatig te wijzigen.

1

Open het  
menuschermb

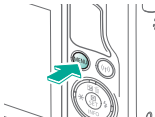

2

Kies het item dat  
u wilt instellen

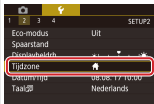

● [👉] → [Tijdzone] →  
knop [SET]

3

Geef uw  
bestemming op

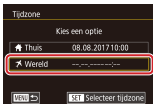

● [🌐] → [Wereld] →  
knop [SET]





Als u in het buitenland bent en wilt dat uw foto's de juiste lokale tijd en datum krijgen, moet u gewoon uw bestemming van tevoren registreren en naar die tijdzone overschakelen. Deze handige functie maakt het onnodig om de datum/tijd-instelling handmatig te wijzigen.

## 4

Schakel over naar de tijdzone van uw bestemming

- Kies een bestemming →

[☀️/☀️] → knop

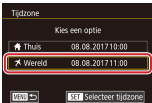

- [ Wereld] → knop **MENU**



# Datum en tijd



Pas de datum en tijd aan.

1

Open het  
menuscher  
m

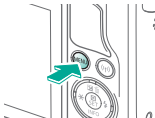

2

Kies het item dat  
u wilt instellen

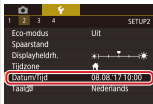

- [F2] → [Datum/Tijd]  
→ knop

3

Stel de camera in



- Blader en pas aan →  
knop





# Weergavetaal



U kunt de weergavetaal desgewenst wijzigen.

1

Open het  
menuscher  
m



2

Kies het item dat  
u wilt instellen

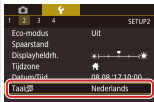

● [2] → [Taal] →  
knop [SET]

3

Stel de camera in



● Selecteer een taal →  
knop [SET]



# Camerageluiden dempen



De camerageluiden kunnen worden gedempt wanneer u de ontspanknop half indrukt of de zelfontspanner instelt.

1

Open het  
menuscher  
m



2

Kies het item dat  
u wilt instellen



- [Y3] → [Pieptoon]  
→ knop

3

Stel de camera in

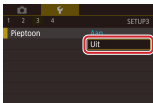

- [Uit] → knop



# Camerageluiden activeren



Geluiden kunnen worden afgespeeld als feedback na camerabediening, zoals knoppen indrukken of het scherm aanraken.

1

Open het  
menuschermb

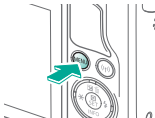

2

Kies het item dat  
u wilt instellen

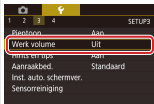

- [Y3] → [Werk  
volume] → knop

3

Stel de camera in

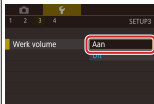

- [Aan] → knop



# Hints en tips verbergen



Normaal gesproken worden hints en tips weergegeven als u items selecteert in het scherm Snelle instelling of opnameschermen. U kunt deze informatie desgewenst uitschakelen.

1

Open het  
menuscherm

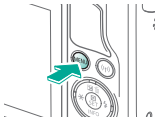

2

Kies het item dat  
u wilt instellen

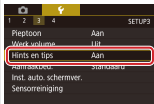

- [F3] → [Hints en tips] → knop

3

Stel de camera in

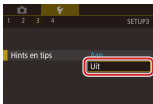

- [Uit] → knop



# Opnamemodi als pictogram weergeven



Geef elke opnamemodus op het selectiescherm alleen als pictogram weer, zonder namen, voor snellere selectie.

1

Stel de modus in



2

Open het  
menuscherm

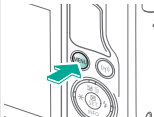

3

Kies het item dat  
u wilt instellen

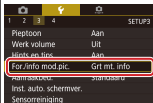

• [Y3] → [For./info  
mod.pic.] → knop





Geef elke opnamemodus op het selectiescherm alleen als pictogram weer, zonder namen, voor snellere selectie.

## 4

Stel de camera in

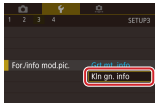

- [Kln gn. info] →  
knop



# Het touchscreen aanpassen



De gevoeligheid van het touchscreen kan worden verhoogd, zodat de camera reageert op een lichtere aanraking.

1

Open het  
menuscher  
m

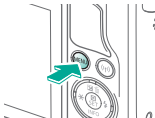

2

Kies het item dat  
u wilt instellen

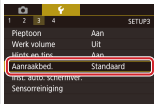

• [3] →  
[Aanraakbed.] →  
knop [SET]

3

Stel de camera in

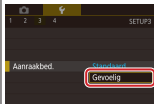

• [Gevoelig] →  
knop [SET]



# Het touchscreen automatisch vergrendelen



Om onbedoelde bediening te voorkomen, kunt u instellen dat het touchscreen automatisch wordt vergrendeld.

1

Open het  
menuschermb

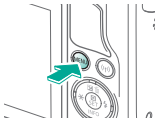

2

Kies het item dat  
u wilt instellen

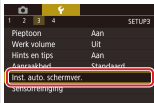

• [Y3] → [Inst. auto.  
schermver.] →  
knop

3

Stel de camera in

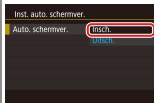





## Het touchscreen automatisch vergrendelen



Om onbedoelde bediening te voorkomen, kunt u instellen dat het touchscreen automatisch wordt vergrendeld.



- [Auto. schermver.] →  
[Insch.] → knop

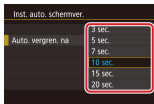

- [Auto. vergren. na]  
→ kies een optie →  
knop



# Automatische sensorreiniging uitschakelen



De beeldsensor wordt automatisch gereinigd om stof te verwijderen wanneer u de camera in- of uitschakelt, of wanneer de camera in de spaarstand gaat. U kunt de automatische reiniging uitschakelen.

1

Open het  
menuschermb

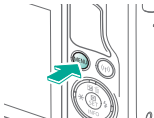

2

Kies het item dat  
u wilt instellen



- [Y3] → [Sensorreiniging] → knop [SET] → [Auto. reiniging] → knop [SET]

3

Stel de camera in



- [Uitsch.] → knop [SET]



# Sensorreiniging activeren



De beeldsensor wordt automatisch gereinigd om stof te verwijderen wanneer u de camera in- of uitschakelt, of wanneer de camera in de spaarstand gaat. U kunt de reiniging indien nodig zelf inschakelen.

1

Open het  
menuschermb

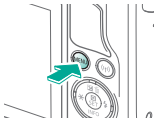

2

Kies het item dat  
u wilt instellen

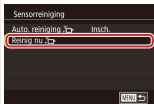

- [3] →  
[Sensorreiniging] →  
knop [SET] →  
[Reinig nu] →  
knop [SET]

3

Voer de bewerking  
uit



- [OK] → knop [SET]



## De sensor handmatig reinigen



Als er na de automatische reiniging nog stof zichtbaar is, kan dit ook worden verwijderd met een optioneel blaasbuisje of ander gespecialiseerd hulpstuk. Het oppervlak van de beeldsensor is zeer gevoelig. Wanneer de sensor handmatig moet worden gereinigd, raden we aan om een serviceverzoek in te dienen bij een helpdesk van de Klantenservice.

1

Zorg dat de camera is uitgeschakeld



2

Verwijder de lens

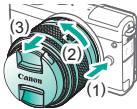

3

Reinig de sensor





# Certificatielogo's controleren



Sommige logo's voor certificatievereisten waaraan de camera voldoet, kunnen op het scherm worden bekeken. Andere certificatielogo's staan in deze handleiding, op de verpakking van de camera of op de camerabehuizing.

1

Open het  
menuschermb

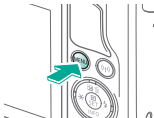

2

Kies het item dat  
u wilt instellen

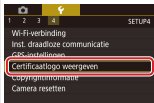

• [4] →  
[Certificaatlogo  
weergeven] →  
knop [SET]



# Auteursrechtinformatie instellen die in beelden moet worden vastgelegd



Als u de naam van de maker en copyrightdetails in beelden wilt opnemen, stelt u deze informatie vooraf in.

1

Open het  
menuscherm

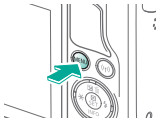

2

Kies het item dat  
u wilt instellen

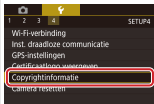

- [4] →  
[Copyrightinformatie]  
→ knop

3

Registreer  
de instellingen



- [Voer naam van auteur in] of [Voer copyrightdetails in]  
→ knop →  
voer een naam in →  
knop **MENU**





## Auteursrechtinformatie instellen die in beelden moet worden vastgelegd



Als u de naam van de maker en copyrightdetails in beelden wilt opnemen, stelt u deze informatie vooraf in.



Voer naam van auteur in

Wijzigingen accepteren?

Nee

Ja

● [Ja] → knop 



# Alle copyrightinformatie verwijderen



U kunt de naam van de maker en de copyrightdetails tegelijk verwijderen.

1

Open het  
menuschermb

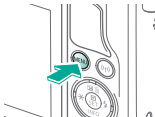

2

Kies het item dat  
u wilt instellen

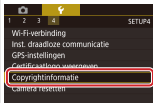

- [4] →  
[Copyrightinformatie]  
→ knop

3

Verwijder



- [Verwijder  
copyrightinfo] →  
knop



- [OK] → knop





# Standaardinstellingen van de camera herstellen



Als u per ongeluk een instelling hebt gewijzigd, kunt u de standaardinstellingen van de camera herstellen.

1

Open het  
menuschermb



2

Kies het item dat  
u wilt instellen

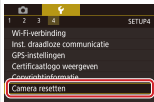

● [4] → [Camera  
resetten] → knop



● [Basisinstell.] →  
knop

3

Voer de bewerking  
uit



● [OK] → knop



# Standaardwaarden herstellen voor afzonderlijke camerafuncties



1

Open het  
menuscherm

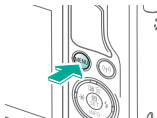

2

Kies het item dat  
u wilt instellen

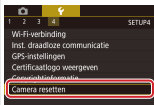

● [F4] → [Camera  
resetten] → knop

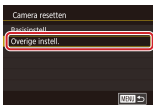

● [Overige instell.] →  
knop

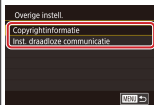

● Kies de functie die  
u wilt resetten →  
knop





## Standaardwaarden herstellen voor afzonderlijke camerafuncties



### 3

Voer de bewerking  
uit



- [OK] → knop





# Index



1-punts (modus AF-kader) 152

## A

Accu

Eco-modus 325

Opladen 22

AE-vergrendeling 124

AF-kaders 152

Afspelen

Aanraakbediening 74

Beeld zoeken 243

Diavoorstelling 236

Digest-films 239

Films 237

Foto's 233

Indexweergave 242

Springweergave 245

Vergrote weergave 234

Alles wissen 264

Aquareleffect (opnamemodus) 107

Aspect ratio 230

Automatische helderheidsoptimalisatie 128

Auto-modus (opnamemodus) 40, 80, 81

Av (opnamemodus) 179



## B

### Beelden

Beveiligen 248, 249, 251, 254

Weergaveduur 318

Wissen 258, 259, 261, 264

### Beelden naar een smartphone

verzenden 296, 299, 302

### Beelden naar webservices verzenden 311

### Beelden verzenden 311

### Beeldstabilisatie 170

### Beeldstijl 139, 140, 141

### Belichting

AE-vergrendeling 124

Compensatie 122

FE-lock 161

### Bestandsnummering 320

### Beveiligen 248, 249, 251, 254

### Bewerken

Formaat wijzigen 269

Rode-Ogen Corr. 276

Trimmen 271

### Bulbelichting 183



## C

### Camera

Resetten 353, 354

Camera Connect 296, 299, 302

CANON iMAGE GATEWAY 305, 310

Classificatie 256

Close-up (opnamemodus) 91

Compressie 227

Correctie chromatische aberratie 172

Correctie helderheid randen 172

Creatieve filters 274

Creatieve hulp (opnamemodus) 193

## D

### Datum/tijd

Instellingen 27

Vervangen 336

Wereldklok 334

Diavoorstelling 236

DLNA 294

Draadloze functies 294

## E

Eco-modus 325

Effect kunst opvallend (opnamemodus) 105



## F

Favorieten 256

FE-vergrendeling 161

Films

    Beeldkwaliteit (resolutie/framerate) 231

    Bewerken 285, 288, 290

Fisheye-effect (opnamemodus) 103

Flitsbelichtingscompensatie 160

Flitser

    FE-lock 161

    Flitsbelichtingscompensatie 160

    Flitsmeting 164

    Flitsoutput 165

    Flitstiming 163

    Modus 159

    Resetten 168

Formaat wijzigen 269

## G

Geheugenkaarten 24

Geluiden 338

Gezicht+volgen 152

## H

Handmatig scherpstellen 145

Handmatige WB 133

Handmatige witbalans 133

High Dynamic Range (opnamemodus) 114

Hoge ISO-ruisreductie 173

Hybride automatisch (opnamemodus) 83



## I

Indexweergave 242

Indicator 68, 316, 317

ISO-snelheid 126

## K

Kleur (witbalans) 132

Kleurtemperatuur 136, 138

Korrelië Z/W (opnamemodus) 99

## L

Landschap (opnamemodus) 90

Lange belichtingstijd 183

Lens

Bevestigen 29

Ontgrendeling 31

Verwijderen 31

## M

M (opnamemodus) 181

Macrofotografie 91

Meetmethode 125

Menu

Aanraakbediening 72

Basishandelingen 64

MF (Handmatige scherpstelling) 145

MF-peaking 150

Miniatureffect (opnamemodus) 111





## N

Nachtopnamen uit hand

(opnamemodus) 95

Namen van onderdelen 48

## O

Opladen 22

## P

P (opnamemodus) 7

Portret (opnamemodus) 88

Prioriteit voor tinten 129

## R

RAW 228

RAW-beeldverwerking 280, 282

Reiniging (beeldsensor) 346, 347, 348

Reizen met de camera 334

Resetten 353, 354

Resolutie (beeldformaat) 227

Riem 21

Rode-Ogen Corr. 276

Roteren 267

Ruisonderdrukking bij meerdere  
opnamen 174

Ruisreductie

Hoge ISO-snelheid 173, 174

Lange belichtingstijd 175

Ruisreductie lange sluitertijd 175



## S

Scherm

Weergavetaal 28

Scherpstelbereik

Handmatig scherpstellen 145

Scherpstellen

AF Frames 152

MF-peaking 150

Servo AF 153

Touch AF 156

Sensorreiniging 346, 347

Servo AF 153

Snel instellen, scherm

Aanraakbediening 70

Basishandelingen 62

Soepele zone AF 152

Softfocus (opnamemodus) 101

Sport (opnamemodus) 92

Springweergave 245

Stof op beelden voorkomen 347, 348

## T

Time-lapse-movie (opnamemodus) 209

Touch AF 156

Touch Shutter 224

Trimmen 271

Tv (opnamemodus) 177



## V

Vergrote weergave 234

Verzadiging 140

Voedsel (opnamemodus) 93

## W

Weergaveduur 318

Weergavetaal 28

Wereldklok 334

Windfilter 214

Wissen 258, 259, 261, 264

Witbalans (kleur) 132

## Z

Zelfontspanner

    Zelfontspanner aanpassen 222

    Zelfontspanner gebruiken 220

Zelfportret (opnamemodus) 86

Zoeken 243

Zoomen 40, 42

Zoomen AF-punt 145

Zwart-witfoto's 99



## Vorzorgsmaatregelen voor draadloze functies (Wi-Fi, Bluetooth en overige)



- Landen en regio's waarin het gebruik van draadloze functies is toegestaan
  - Het gebruik van draadloze functies is beperkt in bepaalde landen en regio's en illegaal gebruik kan strafbaar zijn volgens nationale of lokale voorschriften.  
Om te voorkomen dat u de voorschriften met betrekking tot draadloze communicatie schendt, controleert u op de website van Canon waar het gebruik is toegestaan.  
Houd er rekening mee dat Canon niet aansprakelijk kan worden gehouden voor problemen die voortkomen uit het gebruik van draadloze functies in andere landen en regio's.
- Indien u één van de volgende handelingen uitvoert, kan dit juridische gevolgen hebben:
  - Het product wijzigen of aanpassen
  - De certificeringslabels van het product verwijderen
- Voordat goederen of technologieën in de camera worden geëxporteerd die worden gereguleerd door de Foreign Exchange and Foreign Trade Act (met inbegrip van het meenemen van de goederen of technologieën uit Japan of ze aan niet-ingezetenen laten zien in Japan), is mogelijk een exportvergunning of vergunning voor een servicetransactie nodig van de Japanse overheid.
- Aangezien dit product Amerikaanse coderingsitems bevat, valt het onder de regelgeving van de U.S. Export Administration en mag het product niet worden geëxporteerd naar of binnengebracht worden in een land waarop een handelsembargo van de VS van toepassing is.
- Noteer de draadloze Wi-Fi-instellingen die u gebruikt.





## Vorzorgsmaatregelen voor draadloze functies (Wi-Fi, Bluetooth en overige)



- De draadloze instellingen die op dit product zijn opgeslagen kunnen worden gewijzigd of gewist door foutief gebruik van het product, de gevolgen van radiogolven of statische elektriciteit, of een ongeval of fout.
- Houd er rekening mee dat Canon niet verantwoordelijk is voor directe of indirecte schade of verlies van inkomsten als gevolg van het verslechteren of verdwijnen van inhoud.
- Wanneer u niet meer eigenaar van de camera bent, het product weggooit of ter reparatie opstuurt, dient u de standaardinstellingen voor draadloze communicatie te herstellen door eventuele instellingen te wissen die u hebt ingevoerd.
- Canon compenseert geen schade als gevolg van verlies of diefstal van dit product.
- Canon is niet verantwoordelijk voor schade of verlies als gevolg van ongeoorloofde toegang tot of gebruik van doelapparaten die op dit product zijn geregistreerd doordat het product is verloren of gestolen.
- Gebruik het product zoals aangegeven in deze handleiding.  
Gebruik de draadloze functie van dit product volgens de richtlijnen die in deze handleiding staan beschreven. Canon is niet aansprakelijk voor schade of verlies als de functie en het product op een andere manier worden gebruikt dan in deze handleiding wordt beschreven.
- Gebruik de draadloze functie niet in de buurt van medische apparatuur of andere elektronische apparatuur.

Het gebruik van de draadloze functie in de buurt van medische apparatuur of andere elektronische apparatuur kan de werking van deze apparaten beïnvloeden.





## Vorzorgsmaatregelen voor storing van radiogolven



- Dit product kan storing ondervinden van andere apparaten die radiogolven uitzenden. Om storing te vermijden, moet u dit product zo ver mogelijk van dergelijke apparaten gebruiken of probeert u de apparaten niet op hetzelfde moment als dit product te gebruiken.



# Handelsmerken en licenties



- Microsoft en Windows zijn handelsmerken of gedeponeerde handelsmerken van Microsoft Corporation in de Verenigde Staten en/of andere landen.
- Macintosh en Mac OS zijn handelsmerken van Apple Inc., gedeponeerd in de U.S. en andere landen.
- App Store, iPhone en iPad zijn handelsmerken van Apple Inc.
- Het SDXC-logo is een handelsmerk van SD-3C, LLC.
- HDMI, het HDMI-logo en High-Definition Multimedia Interface zijn handelsmerken of gedeponeerde handelsmerken van HDMI Licensing, LLC.
- Wi-Fi<sup>®</sup>, Wi-Fi Alliance<sup>®</sup>, WPA<sup>™</sup>, WPA2<sup>™</sup> en Wi-Fi Protected Setup<sup>™</sup> zijn handelsmerken of geregistreerde handelsmerken van de Wi-Fi Alliance.
- Het Bluetooth<sup>®</sup>-woordmerk en -logo's zijn gedeponeerde handelsmerken die eigendom zijn van Bluetooth SIG, Inc. en elk gebruik van dergelijke merken door Canon Inc. geschiedt onder licentie. Overige handelsmerken en handelsnamen zijn eigendom van hun respectieve eigenaren.
- De N-markering is een handelsmerk of gedeponeerd handelsmerk van NFC Forum, Inc. in de Verenigde Staten en in andere landen.
- Alle andere handelsmerken zijn eigendom van hun respectieve eigenaren.
- Dit apparaat gebruikt exFAT-technologie die in licentie is gegeven door Microsoft.





- This product is licensed under AT&T patents for the MPEG-4 standard and may be used for encoding MPEG-4 compliant video and/or decoding MPEG-4 compliant video that was encoded only (1) for a personal and non-commercial purpose or (2) by a video provider licensed under the AT&T patents to provide MPEG-4 compliant video. No license is granted or implied for any other use for MPEG-4 standard.

\* Kennisgeving in het Engels weergegeven, zoals vereist.







# Vrijwaring



- Onrechtmatige vereenvoudiging van deze handleiding is verboden.
- Alle metingen zijn gebaseerd op teststandaarden van Canon.
- Deze informatie, de productspecificaties en het uiterlijk kunnen zonder voorafgaande kennisgeving worden gewijzigd.
- De illustraties en schermafbeeldingen in deze handleiding kunnen enigszins afwijken van het werkelijke apparaat.
- Niettegenstaande het bovenstaande kan Canon niet aansprakelijk worden gehouden voor eventuele schade die ontstaat door het gebruik van dit product.

**Canon**